

PRODUCT CATALOG and PRICE LIST **2024**



valid from 1 March 2024



**QUALITY
MADE IN GERMANY
SINCE 1919**



Subsidiaries



WOLFA headquarters Weikersheim

Production & Sales
Friedrich-Wolfarth-Straße 6
D - 97990 Weikersheim-Neubronn

Tel.: 0049 (0) 79 34 / 91 91 0
Fax: 0049 (0) 79 34 / 91 91 50
email: mail@wolfa.de

WOLFA location Frankfurt

Distributing warehouse & Sales
Lauenburger Straße 1
65824 Schwalbach a. Taunus

Tel.: 0049 (0) 61 96 / 7 66 66 0
Fax: 0049 (0) 61 96 / 7 66 66 16
email: nl-frankfurt@wolfa.de
email: k.stiefel@wolfa.de

WOLFA location Mülheim/Ruhr

Distributing warehouse & Sales
Lahnstraße 2
45478 Mülheim-Speldorf

Mobile: 0049 (0) 173 / 85 78 751
email: nl-muelheim@wolfa.de

WOLFA location Naumburg

Production & Distribution center
Südring 5
06618 Mertendorf, OT Görtschen

Tel.: 0049 (0) 3 44 45 / 8 02 0
Fax: 0049 (15) 3 44 45 / 8 02 0
Email: nl-goerschen@wolfa.de

Contacts in the field:

Western Germany:



Roland J. Kögel

Tel.: 0049 (0) 24 26 / 9 9 0369
Mobile: 0049 (0) 160 / 3 60 73 21
email: r.j.koegel@wolfa.de

Region Rhein-Main area/ central:



Ulrich Hermann

Tel.: 0049 (0) 61 96 / 7 66 66 0
Mobile: 0049 (0) 151 / 51 16 10 59
Email: u.hermann@wolfa.de

Sales management Southern Germany



Peter Tschischka

Tel.: 0049 (0) 79 34 / 91 91 37
Mobile: 0049 (0) 170 / 9 22 04 80
email: p.tschischka@wolfa.de

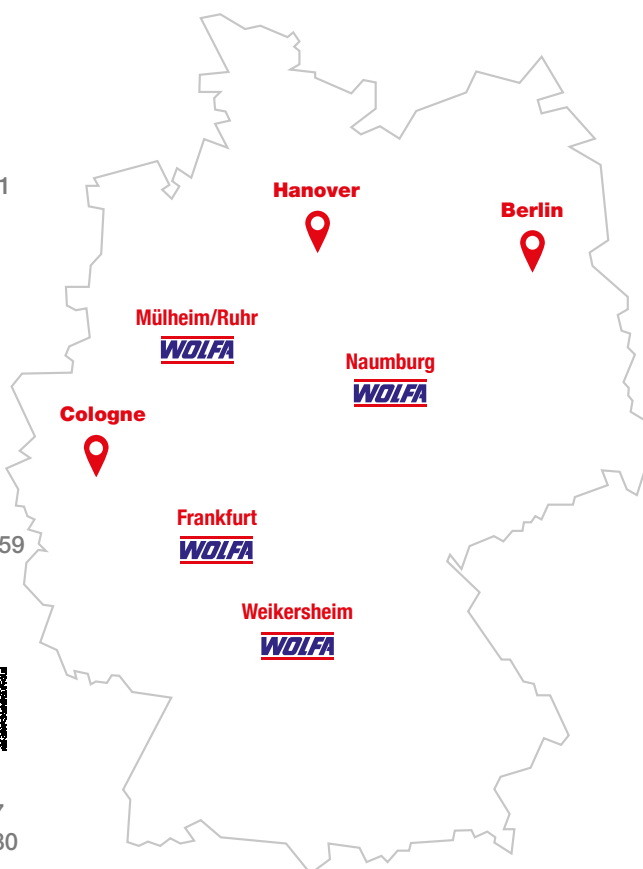

Warehouse:



Warehouse Berlin Sven Meyfarth, WVSM

Frankfurter Chaussee 56
15370 Vogelsdorf
Tel.: 0049 (0) 3 36 38 / 8 98 58
Fax: 0049 (0) 3 36 38 / 8 98 59
Mobile: 0049 (0) 173 / 6 66 92 75
email: sven.meyfarth@t-online.de

Warehouse Hanover SPH Stahlprodukte GmbH & Co. KG

Jörg Nissel u. Martin Bade
Lützerodestraße 12
30161 Hannover

Collection point: Alte Speicherstr. 10,
30453 Hannover-Linden / Hafen
Tel.: 0049 (0) 511 / 12 40 41 60
Fax: 0049 (0) 511 / 12 40 41 11
email: info@stahlprodukte.com

Warehouse Cologne Helmut Schwanz GmbH Im Gewerbegebiet Pesch 10 B

50767 Köln
Tel.: 0049 (0) 221 / 59 09 712
Fax: 0049 (0) 2 21 / 59 09 76
email: s.friebel@wolfa.de
email: j.wagner@wolfa.de
email: n.schwanz@wolfa.de



Terms of delivery:

Our General Terms and Conditions shall apply exclusively. They are provided on the last pages of our price list or on the internet at www.wolfa.de

Freight conditions Germany:

Carriage paid for orders totaling a net goods value of €1200 and more. Deliveries of less than €1200 net goods value are subject to a freight charge of €80. Smaller orders are, if possible, forwarded more cost-effectively via parcel service. Delivery by appointment possible on request at additional cost. Consignments to construction sites or differing delivery addresses are subject to a surcharge of €50. Contact persons and their telephone numbers are required for such cases.

Cost for return shipping:

We take back goods delivered from stock within 4 weeks of delivery and prior approval. In such cases, the processing fee is 25% of the total invoice value. The buyer returns the goods to the Weikersheim factory at his own expense. After we have checked the merchandise, we send you a credit note for the flawless items minus the processing fee. Custom-made products are excluded from return.

Overseas:

Representations and dealerships in 25 countries.
Freight costs as agreed.

We assume no liability for printing errors!
Subject to technical changes!



Building components

Window wells	4-19	1
Insulating elements	20-21	2
Casement windows	22-39	3
Multi-purpose windows	40-55	4
Perforated plates / security grilles	47	5
Cast iron basement windows	56-59	6
Shoe scraper systems	62-63	7
Gratings	64-67	8
Stairs	68	9
Composters / screen sieves	69	10



drainage systems

Drainage gutters	70-101	11
Spot intake / yard catch basin	102-103	



Agriculture

Barn windows	106-107	12
Casement windows plus sizes	108-109	13
Doors	110-111	14
Plastic gratings / feed troughs	112-113	15



Residential windows and doors

Residential windows	114-123	16
Front doors	124-125	17
Insulating glasses	126	18

SPECIALIST IN THE PRODUCTION AND PROCESSING OF GRP FOR OVER 60 YEARS



As one of the first companies in Europe, WOLFA has been producing, processing and handling glass fiber reinforced polyester since 1955.

The particular characteristics of this plastic material, our 60 years of experience and our expertise in producing and processing GRP guarantee unique and unmatched products for a great variety of applications.

WOLFA Profi window wells are made of glass fiber reinforced polyester and compression-molded (SMC) into the final product. The thermosetting plastic material is weather-proof and inherently stable. The material does not become brittle, is UV-resistant and not subject to wear and tear.

GRP - reliable and well-established



Quality Made in Germany – since 1919



Window well systems 6-9

Product information	6
Window wells	7
Gratings	8
Fastening material	9



Window well add-on tops 10



Ventilation shafts 11



Window well all-rounders 12-13



Pressure-water-tight window wells 14-16



Product information	14
---------------------	----



Wall installation	15
-------------------	----

Installation on insulating wall panel	16
---------------------------------------	----

Non-return valve, drain connection	14
------------------------------------	----

Sealing plate (V2A)	14
---------------------	----

Options 17-19

1

PROFI window wells



- Light weight
- Resistant to frost and heat
- Robust and safe
- Painted white to ensure the largest possible light incidence
- All sizes available as pressure-water-tight and car-trafficable versions
- Quality Made in Germany
- All models **with patented edge protection grating**



2

3

4

5

6

WOLFA adds value

WOLFA edge protection gratings are the heaviest and most robust standard gratings on the market. Flush edges thanks to the edge protection grating. Proven its worth millions of times in almost 50 years.

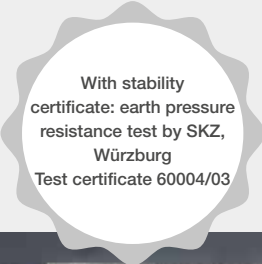

All products with patented edge protection grating

Stylish transition thanks to the surface-mounted grating

7

8

9

10

11

12

Grating designs and load resistances:

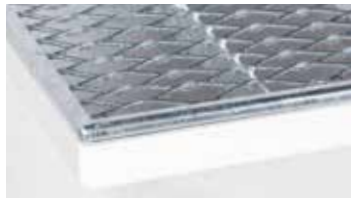

Expanded metal edge protection grating
for loads up to **4.7 kN**

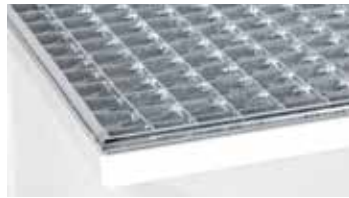

Pressure-locked edge protection grating
Mesh width **30/30**
for loads up to **6.2 kN**

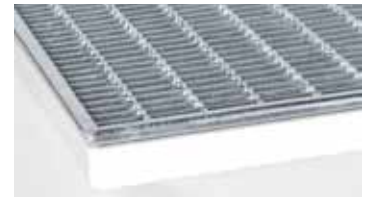

Pressure-locked edge protection grating
Mesh width **30/10**
for loads up to **7.2 kN**
(car-trafficable)

Surcharge for	Price €
Reinforcing bracket 50 x 3 mm	€24 rm
Shorter gratings	80% surcharge

! For sidewalks and patios we recommend pressure-locked edge protection grating mesh width 30/10

16

17

18

Accessories for window wells see pages 14 to 19.

Product information: see page 6

Window wells without grating: standard version

Without fastening material.

Fastening material see page 9.

Size in cm (W x H x D)	Pieces per pallet	Item number	Price €
43 cm installation depth			
81 x 66 x 43	15	301101010	85
81 x 101 x 43	30	301101015	115
101 x 66 x 43	30	301101020	89
101 x 81 x 43	30	301101025	110
101 x 101 x 43	30	301101030	130
101 x 131 x 43	30	301101035	190
126 x 101 x 43	30	301101040	171
126 x 131 x 43	30	301101045	223
60 and 70 cm installation depth			
101 x 101 x 60	20	301101050	144
101 x 131 x 60	20	301101055	231
126 x 101 x 60	30	301101060	211
126 x 131 x 60	20	301101065	266
151 x 121 x 60	15	301101070	455
175 x 80 x 60	15	301101075	408
176 x 81 x 70*	15	301101080	441
201 x 121 x 60	5	301101085	1108

* add-on tops not possible

Window wells without grating: reinforced car-trafficable version

Without fastening material.

Fastening material see page 9.

Size in cm (W x H x D)	Pieces per pallet	Item number	Price €
43 cm installation depth			
81 x 66 x 43	15	301102010	97
81 x 101 x 43	30	301102015	133
101 x 66 x 43	30	301102020	106
101 x 81 x 43	30	301102025	128
101 x 101 x 43	30	301102030	153
101 x 131 x 43	30	301102035	211
126 x 101 x 43	30	301102040	205
126 x 131 x 43	30	301102045	250
60 and 70 cm installation depth			
101 x 101 x 60	20	301102050	191
101 x 131 x 60	20	301102055	275
126 x 101 x 60	30	301102060	250
126 x 131 x 60	20	301102065	314
151 x 121 x 60	15	301102070	558
175 x 80 x 60	15	301102075	496
176 x 81 x 70*	15	301102080	525
201 x 121 x 60	5	301102085	1200

* add-on tops not possible

Accessories for window wells see pages 17 to 19.



ATTENTION: Car-trafficable only
in combination with pressure-locked grating 30/10!

1 Product information: see page 6

2 **Gratings: models**

Grating variants	Size in cm (W x D)	Pieces per pallet	Item number	Price €
43 cm installation depth				
Expanded metal edge protection grating for loads up to 4.7 kN	81 x 43	30	301110110	40
	101 x 43	30	301110120	46
	126 x 43	30	301110130	65
Pressure-locked edge protection grating MW 30/30 car-trafficable up to 6.2 kN	81 x 43	30	301110210	40
	101 x 43	30	301110220	46
	126 x 43	30	301110230	65
Pressure-locked edge protection grating MW 30/10* car-trafficable up to 7.2 kN  (car-trafficable)	81 x 43	30	301110310	59
	101 x 43	30	301110320	68
	126 x 43	30	301110330	86
60 cm and 70 cm installation depth				
Expanded metal edge protection grating for loads up to 4.7 kN	101 x 60	30	301110140	52
	126 x 60	30	301110150	86
	151 x 60	15	301110160	167
	175 x 60	15	301110170	196
	201 x 60	5	301110190	210
Pressure-locked edge protection grating MW 30/30 car-trafficable up to 6.2 kN	101 x 60	30	301110240	52
	126 x 60	30	301110250	86
	151 x 60	15	301110260	167
	175 x 60	15	301110270	196
	176 x 70	15	301110280	208
	201 x 60	5	301110290	210
Pressure-locked edge protection grating MW 30/10* car-trafficable up to 7.2 kN  (car-trafficable)	101 x 60	30	301110340	88
	126 x 60	30	301110350	110
	151 x 60	15	301110360	225
	175 x 60	15	301110370	261
	176 x 70	15	301110380	291
	201 x 60	5	301110390	295

* Cross traffic requires wall grating brackets.



Expanded metal edge protection grating
for loads up to 4.7 kN

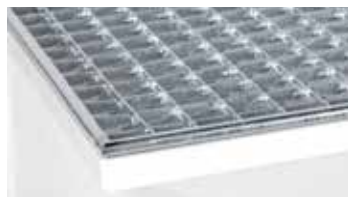

Pressure-locked edge protection grating
Mesh width 30/30
for loads up to 6.2 kN



Pressure-locked edge protection grating
Mesh width 30/10
for loads up to 7.2 kN



Surcharge for	Price €
Reinforcing bracket 50 x 3 mm	€24 rm
Shorter gratings	80% surcharge

! For sidewalks and patios we recommend pressure-locked edge protection grating mesh width 30/10

Accessories for window wells see pages 17 to 19.

Fastening material: Insulation spacer / anchor bolt

Including anti burglary system for window wells and add-on tops.

	Insulation depth in cm up to	Item number	Price €
Concrete walls			
	10	303102020	25
	14	303102010	27
	24.5	303102030	41
	27.5	303102040	46
Brick walls			
	12	303103010	24
	21	303103020	34

or:

Fastening material: Standard fasteners

Including anti burglary system for window wells and add-on tops.

	Item number	Price €
	303101010	6



Window well on insulating element

1 Profi window well tops:

2 Lower basement levels require window well add-on tops to balance out the different ground levels. WOLFA offers a perfectly harmonized system. The PROFI add-ons with their extra strong cross ribs are made-to-measure and easy to push over and screw to the window well.

3 The window well add-on allows stepless heights adjustment from 7 to 33 cm and 7 to 48 cm.

4 Up to three add-ons can be mounted on top of each other. Please note that if two or more add-ons are needed, the reinforced variants and reinforced window wells with their respective bracings must be used.

5 The add-on at the bottom is used for leveling.



! Steep hillside conditions or difficult ground conditions require reinforced window wells, reinforced add-ons and bracings.

Bracings see page 17.

6 Window well add-ons: standard version

Without fastening material. Fastening material see page 19.

Size in cm (W x H x D)	Pieces per pallet	Item number	Price €
43 cm installation depth			
81 x 35 x 43	42	301301010	70
101 x 35 x 43	42	301301015	71
101 x 50 x 43	30	301301017	98
126 x 35 x 43	48	301301020	91
126 x 50 x 43	30	301301022	128
60 cm installation depth			
101 x 35 x 60	28	301301025	85
126 x 35 x 60	32	301301030	110
151 x 35 x 60	40	301301035	210
175 x 35 x 60	40	301301040	249
201 x 35 x 60	-	301301045	314

! NEW

! NEW



! Height-adjustable window well add-on from 7 to up to 33 cm



! NEW Height-adjustable window well add-on from 7 to up to 48 cm

! Easy removal thanks to the flexible fastening points

12 Window well add-ons: reinforced and car-trafficable Design

Without fastening material. Fastening material see page 19.

13

Size in cm (W x H x D)	Pieces per pallet	Item number	Price €
43 cm installation depth			
81 x 35 x 43	42	301302010	85
101 x 35 x 43	42	301302015	91
101 x 50 x 43	30	301302017	128
126 x 35 x 43	48	301302020	111
126 x 50 x 43	30	301302022	158
60 cm installation depth			
101 x 35 x 60	28	301302025	110
126 x 35 x 60	32	301302030	130
151 x 35 x 60	40	301302035	242
175 x 35 x 60	40	301302040	298
201 x 35 x 60	-	301302045	369

! NEW

! NEW



15

Window well add-ons	Size in cm	Item number	Sur-charge €
Back closed (indicate the desired height!)	81 x 35	303400010	158
	101 x 35	303400020	165
	101 x 50	303400025	190
	126 x 35	303400030	171
	126 x 50	303400035	196

! Attention: check grating depth

16

17

18

Accessories for window wells see pages 17 to 19.

Profi ventilation shafts:

Like the window wells, the WOLFA ventilation shafts are made of glass fiber reinforced polyester (GRP) and therefore extremely sturdy and weather-proof.

They are excellent airshafts for underground central heating rooms, cooling rooms and basement spaces in general. All ventilation shafts are supplied with the patented WOLFA edge protection gratings.

The ventilation shafts can be placed on top of each other.



Ventilation shafts: standard version

Without fastening material. Fastening material see page 21.

Grating variants	Size in cm (W x H x D)	Pieces per pallet	Item number	Price €
With expanded metal edge protection grating car-trafficable up to 4.7 kN	36.5x40x20	40	302201310	70
With pressure-locked edge protection grating MW 30/30 car-trafficable up to 6.2 kN			302201210	70
With Pressure-locked edge protection grating MW 30/10 Car-trafficable up to 7.2 kN			302201110	81
Without grating as add-on top			302101010	51

Grating designs and load resistances:

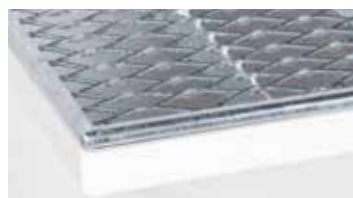

Expanded metal edge protection grating

for loads up to **4.7 kN**

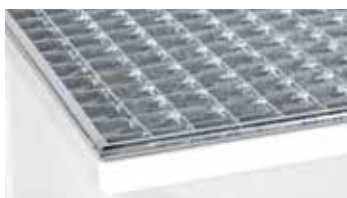

Pressure-locked edge protection grating

Mesh width **30/30**
for loads up to **6.2 kN**

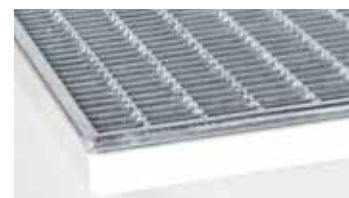

Pressure-locked edge protection grating

Mesh width **30/10**
for loads up to **7.2 kN**

! For sidewalks and patios we recommend pressure-locked edge protection grating mesh width 30/10

Accessories for window wells see pages 17 to 19.

1 PROFI window well all-rounders:

2 Reinforced window well with non-return valve and patented edge protection grating. With pressure-locked grating 30/10, the versions are car-trafficable.

- 3 ■ Light weight
- 4 ■ Resistant to frost and heat
- 5 ■ Robust and safe
- 6 ■ Quality Made in Germany



7 WOLFA adds value

8 WOLFA edge protection gratings are the heaviest and most robust standard gratings on the market. Flush edges thanks to the edge protection grating. Proven its worth millions of times in almost 50 years.

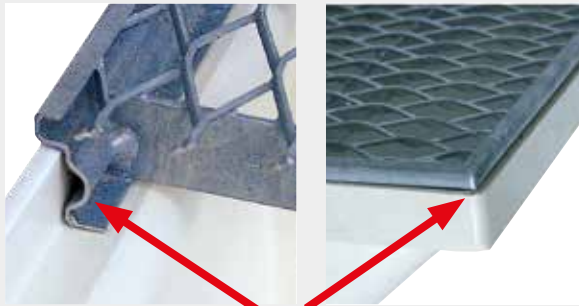
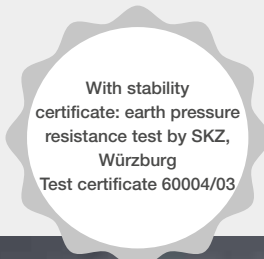

9 All products with patented edge protection grating



10 Stylish transition thanks to the surface-mounted grating

13 Non-return valve included:



14 Certified stopnon-return valve with odor stop.

15 See page 14.

16 ! The non-return valve must be hooked up to a closed wastewater system.





17 Successfully tested allrounder system – window well with non-return valve.

Product information: see page 12

Window well allrounders **KIT** reinforced car-trafficable version

With non-return valve (without fastening material) Car-trafficable only with pressure-locked grating 30/10.
Insulation spacer: see page 21.

Grating variants	Size in cm (W x H x D)	Pieces per pallet	Item number	Price €
43 cm installation depth				
Expanded metal edge protection grating for loads up to 4.7 kN	81 x 66 x 43	15	301402110	242
	81 x 101 x 43	30	301402115	278
	101 x 66 x 43	30	301402120	257
	101 x 81 x 43	30	301402125	279
	101 x 101 x 43	30	301402130	304
	101 x 131 x 43	30	301402135	362
	126 x 101 x 43	30	301402140	375
	126 x 131 x 43	30	301402145	420
Pressure-locked edge protection grating MW 30/30 car-trafficable up to 6.2 kN	81 x 66 x 43	15	301402210	242
	81 x 101 x 43	30	301402215	278
	101 x 66 x 43	30	301402220	257
	101 x 81 x 43	30	301402225	279
	101 x 101 x 43	30	301402230	304
	101 x 131 x 43	30	301402235	362
	126 x 101 x 43	30	301402240	375
	126 x 131 x 43	30	301402245	420
Pressure-locked edge protection grating MW 30/10** car-trafficable up to 7.2 kN  (car-trafficable)	81 x 66 x 43	15	301402310	261
	81 x 101 x 43	30	301402315	297
	101 x 66 x 43	30	301402320	279
	101 x 81 x 43	30	301402325	301
	101 x 101 x 43	30	301402330	326
	101 x 131 x 43	30	301402335	384
	126 x 101 x 43	30	301402340	396
	126 x 131 x 43	30	301402345	441
60 cm and 70 cm installation depth				
Expanded metal edge protection grating for loads up to 4.7 kN	101 x 101 x 60	20	301402150	348
	101 x 131 x 60	20	301402155	432
	126 x 101 x 60	30	301402160	441
	126 x 131 x 60	20	301402165	505
	151 x 121 x 60	15	301402170	830
	175 x 80 x 60	15	301402175	797
	201 x 121 x 60	5	301402185	1515
Pressure-locked edge protection grating MW 30/30 car-trafficable up to 6.2 kN	101 x 101 x 60	20	301402250	348
	101 x 131 x 60	20	301402255	432
	126 x 101 x 60	30	301402260	441
	126 x 131 x 60	20	301402265	505
	151 x 121 x 60	15	301402270	830
	175 x 80 x 60	15	301402275	797
	176 x 81 x 70*	15	301402280	838
	201 x 121 x 60	5	301402285	1515
Pressure-locked edge protection grating MW 30/10** car-trafficable up to 7.2 kN  (car-trafficable)	101 x 101 x 60	20	301402350	384
	101 x 131 x 60	20	301402355	468
	126 x 101 x 60	30	301402360	465
	126 x 131 x 60	20	301402365	529
	151 x 121 x 60	15	301402370	888
	175 x 80 x 60	15	301402375	862
	176 x 81 x 70*	15	301402380	921
	201 x 121 x 60	5	301402385	1600



Certified
non-return valves
with odor stop.

! The non-return valve
must be hooked up
to closed wastewater
system.

* add-on tops not
possible

** cross traffic requires
wall grating brackets.

Options
for window wells see
pages 17 to 19.

1 Pressure-water-tight PROFI window wells:

2 For basements with high groundwater levels or water pressing from below. The PROFI products have been subjected to long-term watertightness tests. The tests carried out at the Leipzig material and test institute showed: All tight and safe!

3 **! Installation directly on the concrete wall**



7 WOLFA adds value:

- 8 ■ Robust and safe
- 9 ■ Proven its worth millions of times in almost 50 years
- 10 ■ Quality Made in Germany
- 11 ■ All models **with patented edge protection grating**



Successfully tested system DWD window well with non-return valve

12 Drainage connection for pressure-water-tight window wells:



Certified **non-return valve** with odor stop and HT drainage adapter element NW 100

Item number	Surcharge in €
303202020	72



Drainage connection NW50 with plug.

Item number	Surcharge in €
303202030	42



Sealing plate (V2A)

Item number	Surcharge in €
303202010	32

All variants with accessories, e.g. sealing rope and sealing and fastening material.

* The non-return valve must be hooked up to a closed wastewater system.

Product information: see page 6

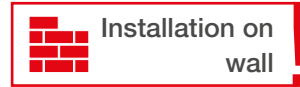

Pressure-water-tight window wells **KIT** Closed bottom

All variants with additional rail mounting kit, sealing rope and sealing material; fastening material included.

! Wall installation

Grating variants	Size in cm (W x H x D)	Pieces per pallet	Item number	Price €
43 cm installation depth				
Expanded metal edge protection grating for loads up to 4.7 kN	81 x 66 x 43	15	301502110	347
	81 x 101 x 43	30	301502115	387
	101 x 66 x 43	30	301502120	366
	101 x 81 x 43	30	301502125	388
	101 x 101 x 43	30	301502130	416
	101 x 131 x 43	30	301502135	478
	126 x 101 x 43	30	301502140	490
	126 x 131 x 43	30	301502145	538
Pressure-locked edge protection grating MW 30/30 car-trafficable up to 6.2 kN	81 x 66 x 43	15	301502210	347
	81 x 101 x 43	30	301502215	387
	101 x 66 x 43	30	301502220	366
	101 x 81 x 43	30	301502225	388
	101 x 101 x 43	30	301502230	416
	101 x 131 x 43	30	301502235	478
	126 x 101 x 43	30	301502240	490
	126 x 131 x 43	30	301502245	538
Pressure-locked edge protection grating MW 30/10 car-trafficable up to 7.2 kN	81 x 66 x 43	15	301502310	366
	81 x 101 x 43	30	301502315	406
	101 x 66 x 43	30	301502320	388
	101 x 81 x 43	30	301502325	410
	101 x 101 x 43	30	301502330	438
	101 x 131 x 43	30	301502335	500
	126 x 101 x 43	30	301502340	511
	126 x 131 x 43	30	301502345	559
60 cm and 70 cm installation depth				
Expanded metal edge protection grating for loads up to 4.7 kN	101 x 101 x 60	20	301502150	460
	101 x 131 x 60	20	301502155	548
	126 x 101 x 60	30	301502160	556
	126 x 131 x 60	20	301502165	623
	151 x 121 x 60	15	301502170	972
	175 x 80 x 60	15	301502175	914
	201 x 121 x 60	5	301502185	1,677
Pressure-locked edge protection grating MW 30/30 car-trafficable up to 6.2 kN	101 x 101 x 60	20	301502250	460
	101 x 131 x 60	20	301502255	548
	126 x 101 x 60	30	301502260	556
	126 x 131 x 60	20	301502265	623
	151 x 121 x 60	15	301502270	972
	175 x 80 x 60	15	301502275	914
	176 x 81 x 70*	15	301502280	955
	201 x 121 x 60	5	301502285	1,677
Pressure-locked edge protection grating MW 30/10 car-trafficable up to 7.2 kN	101 x 101 x 60	20	301502350	496
	101 x 131 x 60	20	301502355	584
	126 x 101 x 60	30	301502360	580
	126 x 131 x 60	20	301502365	647
	151 x 121 x 60	15	301502370	1,030
	175 x 80 x 60	15	301502375	979
	176 x 81 x 70*	15	301502380	1,038
	201 x 121 x 60	5	301502385	1,737

! Add-ons
for pressure-water-tight window wells are not water-proof.

! Choose your drainage connection
See page 14



For pressure-water-tight window wells with closed bottom
we recommend our window well covers see pages 18 to 19

* add-on tops not possible

1 Product information: See page 14

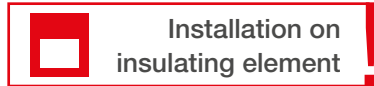

Installation on
insulating element

2 **Pressure-water-tight window wells KIT Closed bottom**

—Complete with self-drilling screws, sealing rope and sealing material.

3 **! Installation on insulating element**

Grating variants	Size in cm (W x H x D)	Pieces per pallet	Item number	Price €	
43 cm installation depth					
Expanded metal edge protection grating for loads up to 4.7 kN	81 x 66 x 43	15	301552110	271	
	81 x 101 x 43	30	301552115	308	
	101 x 66 x 43	30	301552120	287	
	101 x 81 x 43	30	301552125	309	
	101 x 101 x 43	30	301552130	336	
	101 x 131 x 43	30	301552135	397	
	126 x 101 x 43	30	301552140	410	
Pressure-locked edge protection grating MW 30/30 car-trafficable up to 6.2 kN	126 x 131 x 43	30	301552145	457	
	81 x 66 x 43	15	301552210	271	
	81 x 101 x 43	30	301552215	308	
	101 x 66 x 43	30	301552220	287	
	101 x 81 x 43	30	301552225	309	
	101 x 101 x 43	30	301552230	336	
	101 x 131 x 43	30	301552235	397	
Pressure-locked edge protection grating MW 30/10 car-trafficable up to 7.2 kN	126 x 101 x 43	30	301552240	410	
	126 x 131 x 43	30	301552245	457	
	81 x 66 x 43	15	301552310	290	
	81 x 101 x 43	30	301552315	327	
	101 x 66 x 43	30	301552320	309	
	101 x 81 x 43	30	301552325	331	
	101 x 101 x 43	30	301552330	358	
60 cm installation depth	101 x 131 x 43	30	301552335	419	
	126 x 101 x 43	30	301552340	431	
	126 x 131 x 43	30	301552345	478	
	Expanded metal edge protection grating for loads up to 4.7 kN	101 x 101 x 60	20	301552150	380
		101 x 131 x 60	20	301552155	467
		126 x 101 x 60	30	301552160	476
		126 x 131 x 60	20	301552165	542
151 x 121 x 60		15	301552170	877	
Pressure-locked edge protection grating MW 30/30 car-trafficable up to 6.2 kN	101 x 101 x 60	20	301552250	380	
	101 x 131 x 60	20	301552255	467	
	126 x 101 x 60	30	301552260	476	
	126 x 131 x 60	20	301552265	542	
	151 x 121 x 60	15	301552270	877	
Pressure-locked edge protection grating MW 30/10 car-trafficable up to 7.2 kN	101 x 101 x 60	20	301552350	416	
	101 x 131 x 60	20	301552355	503	
	126 x 101 x 60	30	301552360	500	
	126 x 131 x 60	20	301552365	566	
	151 x 121 x 60	15	301552370	935	

4 **! Add-ons**
for pressure-water-tight
window wells are
not water-proof.

5 **! Choose your
drainage
connection**
See page 14





6 **For pressure-water-tight
window wells with
closed bottom**
we recommend our
window well covers
see pages 18 to 19

7 **Accessories** for window wells see pages 17 to 19.

Window well accessories: drainage connections

A well thought out and extensive range of accessories complements the window well system.

Drainage connections	Description	Item number	Price €
	Drainage connection for PROFI line, with NW70 drainage outlet	303200010	16
	Drainage connection with leaf screen For PROFI line, with NW 70 drainage outlet Detachable leaf screen and odor stop	303200020	27
	HT drainage adapter element Nominal width 50/100 mm	303200110	12
	Nominal width 70/100 mm	303200120	12

Window well accessories: Bracings

For optimum reinforcement of window well and tops. We recommend the use of our bracings if more than one top is added on.

	Size in cm (W x H x D)	Item number	Price €
	43 cm installation depth		
	81	303300010	35
	101	303300020	35
	126	303300030	35
60 cm installation depth			
	101	303300040	35
	126	303300050	35
	151	303300060	69
	175	303300070	71
	201	303300080	75

1

Window well covers: high-grade steel fabric

Optically attractive and safe protection against mice, spiders and other vermin.–keeps leaves out.

2



Window well size in cm	Cover in cm (width x depth)	Item number	Price €
43 cm installation depth			
Width 81	86 x 42	303500010	243
Width 101	105 x 42	303500020	264
Width 126	131.5 x 42	303500040	294
60 cm installation depth			
Width 101	105 x 58.5	303500050	278
Width 126	131.5 x 58.5	303500060	316
Width 151	155.5 x 58.5	303500070	340

3

4

5

6

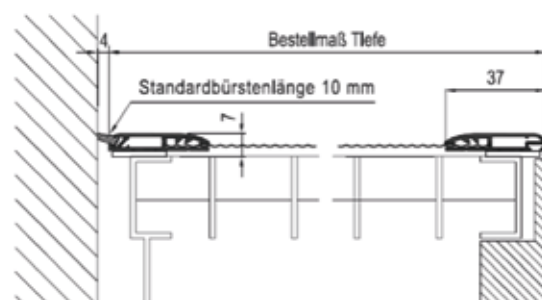
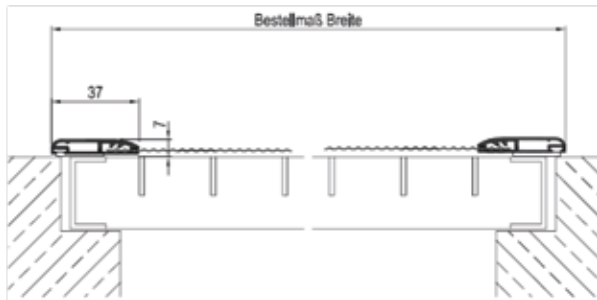

7

8

Note: The depth of 42 cm resp. 58.5 cm refers to window well installation on the unplastered wall, i.e. the wall is plastered after window well installation. If the walls are not plastered at a later point in time, add 1 cm to the depth of the cover when you order.

9

10

Window well covers: Acrylic glass

Swing – Flexible version with seal, can be pulled up.

11



Window well size in cm	Cover in cm (width x depth)	Item number	Price €
43 cm installation depth			
81 x 43	90 x 54	303602010	169
101 x 43	110 x 54	303602020	206
126 x 43	135 x 54	303602040	242
60 cm installation depth			
101 x 60	110 x 75	303602050	255
126 x 60	135 x 75	303602060	296
151 x 60	160 x 75	303602070	349

12

13

14

FIX – Stationary hinged version.

15



Window well size in cm	Cover in cm (width x depth)	Item number	Price €
43 cm installation depth			
81 x 43	90 x 54	303601010	151
101 x 43	110 x 54	303601020	188
126 x 43	135 x 54	303601040	255
60 cm installation depth			
101 x 60	110 x 75	303601050	245
126 x 60	135 x 75	303601060	285
151 x 60	160 x 75	303601070	324

16

17

18

Window well covers: ESG

ESG 5 mm with frame. Fastened with 2 rails, foldable

	Size in cm (width x depth)	Cover in cm (width x depth)	Item number	Price €
	43 cm installation depth			
	Width 81	90 x 54	303603010	85
	Width 101	110 x 54	303603020	92
	Width 126	135 x 54	303603040	112
60 cm installation depth				
	Width 101	110 x 75	303603050	105
	Width 126	135 x 75	303603060	134
	Width 151	160 x 75	303603070	159

Fastening material: Insulation spacer / anchor bolt

For window well installation on insulated walls

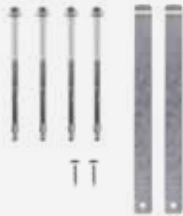
	Insulation depth in cm up to	Item number	Price €
	Concrete walls		
	10	303102020	25
	14	303102010	27
	24.5	303102030	41
	27.5	303102040	46
Brick walls			
	12	303103010	24
	21	303103020	34

Fastening material: Standard fasteners

Including anti burglary system for window wells and add-on tops.

	Item number	Price €
		303101010

Length of grating lock: 20 cm.
Extended grating locks on request!

Fastening material: grating lock as chain lock

Picture	Description	Price €
	2 x chain lock with bracket	14

Product information:

The insulating WOLFA wall panels made of glass fiber reinforced polyester GRP with significant advantages over conventional systems.

- Shell made of glass fiber reinforced polyester, No fiber cement, same color as the window well
- No finishing work such as painting or plaster works
- Simple window well installation with self-drilling screws, no time-consuming installation of the insulation material with dowels, Installation with anchor bolts possible
- Flexible window well placement, no rigid fixing points
- Insulation protected by the wraparound GRP shell
- Break-proof

NEW Insulating element type E

The closed element (no window opening) sized 173.5 x 143 cm allows high flexibility during window well installation. Suitable for all window types.

GRP insulating element

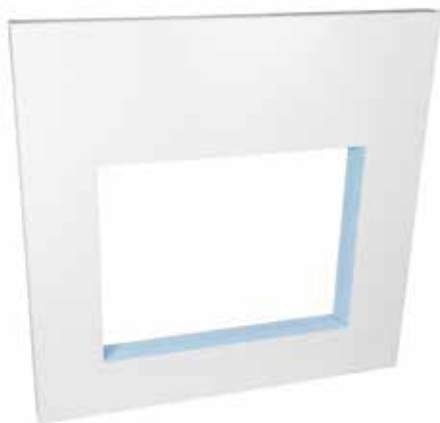

- ! Customized window opening € 30.
- ! Other insulation thicknesses upon request.

GRP base elements

Height increase up to 70 cm



- ! Other insulation thicknesses upon request.

GRP insulating element in cm (W x H)	Insulation thickness in cm	Item number	Price €
Type A 123.5 x 113	10	251010100	220
	12	251010150	231
	14	251010200	242
	16	251010250	251
	18	251010300	322
	20	251010350	348
Type B 123.5 x 143	10	251020100	296
	12	251020150	305
	14	251020200	316
	16	251020250	328
	18	251020300	423
	20	251020350	464
Type C 148.5 x 113	10	251030100	301
	12	251030150	313
	14	251030200	322
	16	251030250	336
	18	251030300	432
	20	251030350	473
Type D 148.5 x 143	10	251040100	336
	12	251040150	344
	14	251040200	357
	16	251040250	372
	18	251040300	478
	20	251040350	528
Type E 173.5 x 143	10	251050100	478
	12	251050150	490
	14	251050200	500
	16	251050250	525
	18	251050300	537
	20	251050350	561
GRP base element in cm (W x H)	Insulation thickness in cm	Item number	Price €
Type 1 123.5 x 40	10	253010100	110
	12	253010150	116
	14	253010200	121
	16	253010250	128
	18	253010300	163
	20	253010350	186
Type 2 123.5 x 70	10	253020100	146
	12	253020150	153
	14	253020200	161
	16	253020250	167
	18	253020300	214
	20	253020350	247
Type 3 148.5 x 40	10	253030100	133
	12	253030150	139
	14	253030200	145
	16	253030250	150
	18	253030300	194
	20	253030350	223
Type 4 148.5 x 70	10	253040100	176
	12	253040150	185
	14	253040200	192
	16	253040250	200
	18	253040300	258
	20	253040350	298
Type 5 173.5 x 70	10	253050100	239
	12	253050150	245
	14	253050200	250
	16	253050250	262
	18	253050300	293
	20	253050350	331

Perimeter masking: insulation thickness 10 to 18 cm



Casement size in cm (W x H)	Item number	Price €
75 x 50	209000601	68
75 x 62.5	209000602	70
75 x 75	209000603	77
87.5 x 50	209000604	75
87.5 x 62.5	209000605	78
87.5 x 75	209000606	87
100 x 50	209000607	82
100 x 62.5	209000608	88
100 x 75	209000609	99
100 x 100	209000610	104
125 x 62.5	209000611	99
125 x 75	209000612	104
125 x 100	209000613	118
125 x 125	209000614	135

NEW

Perimeter masking for customized window sizes upon request!

Cut to fit other openings € 18

Cut to specific insulation thickness subject to specification € 7

! Perimeter masking without insulation elements: see page 37.

Accessories: Sealing kit for pressure-water-tight version



Sealing kit insulation element

20 kg WOLFA-Flex, fleece tape sealing strips
20 cm x 150 cm, 3 strips, 2 corner fleece braces

255010900

258

Accessories: Sealing kit for standard version

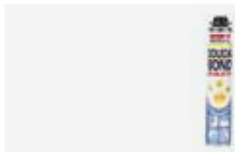

"Easy" glue for insulation elements, 800 ml

255010920

24





Casement windows

In combination with our multi-chamber profiles and insulating glasses, WOLFA casement windows guarantee optimum thermal insulation up to a U_w -value of $0.85 \text{ W/m}^2\text{K}$. The glass fiber compound and thermosetting polyester resin of the casement ensure highest stability and shape retention even if exposed to frost, heat and a variety of chemicals. The many different types of casement windows cover all areas of application and leave nothing to be desired.



- Highest living comfort
- U_w -value up to $0.85 \text{ W/m}^2\text{K}$
- Robust and enduring



1
2
3
4
5
6
7
8
9
10
11
12
13
14
15
16
17
18



Casement window systems 22-28

Casement window Z82 as KIT - tilt & turn 	24
Casement window Z82 as KIT - fixed window pane	25
Casement window Z82 – without sash	26
Casement window Z82 as KIT - sash only - tilt & turn 	27



Casement

Insulated casement type ZOW 	28
Non-insulated casement type ZO	28



Casement inserts tilt, tilt & turn 29-34

ZO-MDK – tilt & turn	29
ZO-PLUS – tilt	30-31
ZO-TOP – tilt	32
ZO-FIB – fixed window pane	33
ZO-SD1 and ZO-SD2	34
ZO-SF1 and ZO-SF2	35

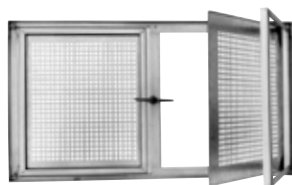

Options 36-38

Thermally insulated casement window **KIT**: Z82 – tilt & turn

The Z82 with 7-chamber profile and an installation depth of 82 mm is a triple-paned Ug 0.6 insulating window with warm edges, offset surfaces with double window rebate seal and safety one-hand tilt & turn profile Roto NX with increased safety feature owed to mushroom pin lock. Inserted in a heat insulated casement made of glass fiber reinforced polyester. Wood bracing included. Available as tilt & turn DIN right or DIN left. Standard consignment is DIN right unless indicated differently.



Accessories for casement windows see pages 36 to 38.

! Special dimensions such as 75 x 100 or 87.5 x 100 cm upon request.

Color(s):



white

! Double sash window possible from a width of 125 cm. Tilt & turn / tilt & turn

Type Z82
Tilt & turn sash DIN right

For concrete walls: **82 mm installation depth**

Casement size in cm / Wall depth in cm	Pieces per pallet	Item number R	Item number L	Price €
75 x 50				
20	24	201001001	201001015	381
24	20	201001101	201001115	381
25	16	201001201	201001215	381
30	16	201001301	201001315	387
75 x 62.5				
20	18	201001002	201001016	401
24	15	201001102	201001116	401
25	12	201001202	201001216	401
30	12	201001302	201001316	408
75 x 75				
20	13	201001003	201001017	420
24	11	201001103	201001117	420
25	9	201001203	201001217	420
30	9	201001303	201001317	431
87.5 x 50				
20	24	201001004	201001018	403
24	20	201001104	201001118	403
25	16	201001204	201001218	403
30	16	201001304	201001318	408
87.5 x 62.5				
20	18	201001005	201001019	422
24	15	201001105	201001119	422
25	12	201001205	201001219	422
30	12	201001305	201001319	434

! Single sash:

Casement size in cm / Wall depth in cm	Pieces per pallet	Item number R	Item number L	Price €
125 x 62.5				
20	18	201001011	201001025	541
24	15	201001111	201001125	541
25	12	201001211	201001225	541
30	12	201001311	201001325	552
125 x 75				
20	13	201001012	201001026	591
24	11	201001112	201001126	591
25	9	201001212	201001226	591
30	9	201001312	201001326	605
125 x 100				
20	12	201001013	201001027	639
24	10	201001113	201001127	639
25	8	201001213	201001227	639
30	8	201001313	201001327	646
125 x 125				
20	12	201001014	201001028	728
24	10	201001114	201001128	728
25	8	201001214	201001228	728
30	8	201001314	201001328	740

Casement size in cm / Wall depth in cm	Pieces per pallet	Item number R	Item number L	Price €
87.5 x 75				
20	13	201001006	201001020	446
24	11	201001106	201001120	446
25	9	201001206	201001220	446
30	9	201001306	201001320	453
100 x 50				
20	24	201001007	201001021	425
24	20	201001107	201001121	425
25	16	201001207	201001221	425
30	16	201001307	201001321	432
100 x 62.5				
20	18	201001008	201001022	445
24	15	201001108	201001122	445
25	12	201001208	201001222	445
30	12	201001308	201001322	452
100 x 75				
20	13	201001009	201001023	475
24	11	201001109	201001123	475
25	9	201001209	201001223	475
30	9	201001309	201001323	481
100 x 100				
20	12	201001010	201001024	528
24	10	201001110	201001124	528
25	8	201001210	201001224	528
30	8	201001310	201001324	532

! Double sash:

Casement size in cm / Wall depth in cm	Pieces per pallet	Item number	Price €
125 x 62.5			
20	18	201001029	696
24	15	201001129	696
25	12	201001229	696
30	12	201001329	707
125 x 75			
20	13	201001030	751
24	11	201001130	751
25	9	201001230	751
30	9	201001330	765
125 x 100			
20	12	201001031	806
24	10	201001131	806
25	8	201001231	806
30	8	201001331	813
125 x 125			
20	12	201001032	849
24	10	201001132	849
25	8	201001232	849
30	8	201001332	861

Insulated casement window **KIT**: Z82-FIB – fixed window pane



The Z82 with 7-chamber profile and an installation depth of 82 mm comes with a triple-paned Ug 0.6 insulating window with warm edges. Inserted in a heat insulated casement made of glass fiber reinforced polyester. Wood bracing included.

Delivery included
Wood bracing and foil
For all casement windows



Color(s):



white

Type Z82-FIB
Fixed window pane

Accessories for casement windows see pages 36 to 38.

! Special dimensions such as 75 x 100 or 87.5 x 100 cm upon request.

For concrete walls: 82 mm installation depth

Casement size in cm / Wall depth in cm	Pieces per pallet	Item number	Price €
75 x 50			
20	24	201004001	283
24	20	201004101	283
25	16	201004201	283
30	16	201004301	289
75 x 62.5			
20	18	201004002	297
24	15	201004102	297
25	12	201004202	297
30	12	201004302	304
75 x 75			
20	13	201004003	309
24	11	201004103	309
25	9	201004203	309
30	9	201004303	320
87.5 x 50			
20	24	201004004	299
24	20	201004104	299
25	16	201004204	299
30	16	201004304	304
87.5 x 62.5			
20	18	201004005	311
24	15	201004105	311
25	12	201004205	311
30	12	201004305	323

Casement size in cm / Wall depth in cm	Pieces per pallet	Item number	Price €
87.5 x 75			
20	13	201004006	328
24	11	201004106	328
25	9	201004206	328
30	9	201004306	335
100 x 50			
20	24	201004007	313
24	20	201004107	313
25	16	201004207	313
30	16	201004307	320
100 x 62.5			
20	18	201004008	327
24	15	201004108	327
25	12	201004208	327
30	12	201004308	334
100 x 75			
20	13	201004009	350
24	11	201004109	350
25	9	201004209	350
30	9	201004309	356
100 x 100			
20	12	201004010	388
24	10	201004110	388
25	8	201004210	388
30	8	201004310	392

Casement size in cm / Wall depth in cm	Pieces per pallet	Item number	Price €
125 x 62.5			
20	18	201004011	392
24	15	201004111	392
25	12	201004211	392
30	12	201004311	403
125 x 75			
20	13	201004012	430
24	11	201004112	430
25	9	201004212	430
30	9	201004312	444
125 x 100			
20	12	201004013	469
24	10	201004113	469
25	8	201004213	469
30	8	201004313	476
125 x 125			
20	12	201004014	528
24	10	201004114	528
25	8	201004214	528
30	8	201004314	540

Casement windows: Z82 – without sash

Z82 with an installation depth of 82 mm, offset surfaces without sash. Inserted in an insulating casement made of glass fiber reinforced polyester. Available for tilt & turn DIN right, DIN left or with fixed window pane. Standard consignment is DIN right unless indicated differently.



Color(s):



white

Type Z82 with frame, prepared for tilt & turn sash DIN right. Also available with fixed window pane.

Accessories for casement windows see pages 36-38.

! Special dimensions such as 75 x 100 or 87.5 x 100 cm upon request.

! Double sash window possible from a width of 125 cm. Tilt & turn / tilt & turn

For concrete walls: 82 mm installation depth

Casement size in cm / Wall depth in cm	Pieces per pallet	Item number R	Item number L	Price €
75 x 50				
20	24	201002001	201002015	129
24	20	201002101	201002115	129
25	16	201002201	201002215	129
30	16	201002301	201002315	135
75 x 62.5				
20	18	201002002	201002016	136
24	15	201002102	201002116	136
25	12	201002202	201002216	136
30	12	201002302	201002316	143
75 x 75				
20	13	201002003	201002017	140
24	11	201002103	201002117	140
25	9	201002203	201002217	140
30	9	201002303	201002317	151
87.5 x 50				
20	24	201002004	201002018	138
24	20	201002104	201002118	138
25	16	201002204	201002218	138
30	16	201002304	201002318	143
87.5 x 62.5				
20	18	201002005	201002019	140
24	15	201002105	201002119	140
25	12	201002205	201002219	140
30	12	201002305	201002319	152

! Single sash:

Casement size in cm / Wall depth in cm	Pieces per pallet	Item number R	Item number L	Price €
125 x 62.5				
20	18	201002011	201002025	182
24	15	201002111	201002125	182
25	12	201002211	201002225	182
30	12	201002311	201002325	193
125 x 75				
20	13	201002012	201002026	198
24	11	201002112	201002126	198
25	9	201002212	201002226	198
30	9	201002312	201002326	212
125 x 100				
20	12	201002013	201002027	219
24	10	201002113	201002127	219
25	8	201002213	201002227	219
30	8	201002313	201002327	226
125 x 125				
20	12	201002014	201002028	247
24	10	201002114	201002128	247
25	8	201002214	201002228	247
30	8	201002314	201002328	259

Casement size in cm / Wall depth in cm	Pieces per pallet	Item number R	Item number L	Price €
87.5 x 75				
20	13	201002006	201002020	152
24	11	201002106	201002120	152
25	9	201002206	201002220	152
30	9	201002306	201002320	159
100 x 50				
20	24	201002007	201002021	144
24	20	201002107	201002121	144
25	16	201002207	201002221	144
30	16	201002307	201002321	151
100 x 62.5				
20	18	201002008	201002022	151
24	15	201002108	201002122	151
25	12	201002208	201002222	151
30	12	201002308	201002322	158
100 x 75				
20	13	201002009	201002023	162
24	11	201002109	201002123	162
25	9	201002209	201002223	162
30	9	201002309	201002323	168
100 x 100				
20	12	201002010	201002024	182
24	10	201002110	201002124	182
25	8	201002210	201002224	182
30	8	201002310	201002324	186

! Double sash:

Casement size in cm / Wall depth in cm	Pieces per pallet	Item number	Price €
125 x 62.5			
20	18	201002029	236
24	15	201002129	236
25	12	201002229	236
30	12	201002329	247
125 x 75			
20	13	201002030	254
24	11	201002130	254
25	9	201002230	254
30	9	201002330	268
125 x 100			
20	12	201002031	278
24	10	201002131	278
25	8	201002231	278
30	8	201002331	285
125 x 125			
20	12	201002032	290
24	10	201002132	290
25	8	201002232	290
30	8	201002332	301

Casement windows: Z82 as KIT - sash only - tilt & turn

The sash for Z82 with an installation depth of 82 mm is a triple-paned Ug 0.6 insulating window with warm edges, offset surfaces with double window rebate seal and safety one-hand tilt & turn profile Roto NX with increased safety feature owed to mushroom pin lock. Available as tilt & turn DIN right, DIN left. Standard consignment is DIN right unless indicated differently.



Accessories for casement windows see pages 36 to 38.

! Special dimensions such as 75 x 100 or 87.5 x 100 cm upon request.

! Double sash window possible from a width of 125 cm. Tilt & turn / tilt & turn

Color(s):



white

Type Z82 sash only
Tilt & turn sash DIN right

82 mm installation depth

! Single sash:

Casement size in cm / Wall depth in cm	Visible glass pane m ²	Item number R	Item number L	Price €
75 x 50	0.10	201003001	201003015	252
75 x 62.5	0.15	201003002	201003016	265
75 x 75	0.21	201003003	201003017	280
87.5 x 50	0.12	201003004	201003018	265
87.5 x 62.5	0.19	201003005	201003019	282
87.5 x 75	0.27	201003006	201003020	294
100 x 50	0.15	201003007	201003021	281
100 x 62.5	0.24	201003008	201003022	294
100 x 75	0.32	201003009	201003023	313
100 x 100	0.50	201003010	201003024	346
125 x 62.5	0.32	201003011	201003025	359
125 x 75	0.44	201003012	201003026	393
125 x 100	0.68	201003013	201003027	420
125 x 125	0.92	201003014	201003028	481

! Double sash:

Casement size in cm / Wall depth in cm	Visible glass pane m ²	Item number	Price €
125 x 62.5	0.26	201003029	460
125 x 75	0.36	201003030	497
125 x 100	0.55	201003031	528
125 x 125	0.75	201003032	560



Insulating casement: ZOW

Insulating casement made of glass fiber reinforced polyester, extra robust. Free choice of window, especially suitable: WOLFA basement windows PLUS, WOLFA multi-purpose windows TOP or MDK, WOLFA cast iron basement windows SD or SF.



Color(s):



white

Type ZOW, Insulated without window insert

Custom-made WOLFA – products

! Special dimensions such as 50 x 100 or 75 x 100 cm upon request.

! Available also for wall depths between 14 and 20 cm up to a size of 100 x 100 cm.

! Version with non-insulated casement

reduced by € 11

! Casement window plus sizes see pages 108 and 109

Accessories for casement windows see pages 36 to 38.

For concrete walls:

Casement size in cm / Wall depth in cm	Pcs/pallet	Item number	Price €
75 x 50			
20	24	206000101	118
24	20	206000201	118
25	16	206000301	118
30	16	206000401	124
36.5	12	206000501	135
39.5	12	206000601	138
75 x 62.5			
20	18	206000102	122
24	15	206000202	122
25	12	206000302	122
30	12	206000402	129
36.5	9	206000502	139
39.5	9	206000602	141
75 x 75			
20	13	206000103	124
24	11	206000203	124
25	9	206000303	124
30	9	206000403	135
36.5	7	206000503	141
39.5	7	206000606	144
87.5 x 50			
20	24	206000104	124
24	20	206000204	124
25	16	206000304	124
30	16	206000404	129
36.5	12	206000504	140
87.5 x 62.5			
20	18	206000105	126
24	15	206000205	126
25	12	206000305	126
30	12	206000405	138
36.5	9	206000505	142

Casement size in cm / Wall depth in cm	Pcs/pallet	Item number	Price €
87.5 x 75			
20	13	206000106	133
24	11	206000206	133
25	9	206000306	133
30	9	206000406	140
36.5	7	206000506	145
100 x 50			
20	24	206000107	128
24	20	206000207	128
25	16	206000307	128
30	16	206000407	135
36.5	12	206000507	141
39.5	12	206000607	144
100 x 62.5			
20	18	206000108	132
24	15	206000208	132
25	12	206000308	132
30	12	206000408	139
36.5	9	206000508	144
39.5	9	206000608	146
100 x 75			
20	13	206000109	145
24	11	206000209	145
25	9	206000309	145
30	9	206000409	151
36.5	7	206000509	156
39.5	7	206000609	159
100 x 100			
20	12	206000110	161
24	10	206000210	161
25	8	206000310	161
30	8	206000410	165
36.5	6	206000510	175
39.5	6	206000610	179

Casement size in cm / Wall depth in cm	Pcs/pallet	Item number	Price €
125 x 62.5			
20	18	206000111	150
24	15	206000211	150
25	12	206000311	150
30	12	206000411	161
36.5	9	206000511	167
39.5	9	206000611	174
125 x 75			
20	13	206000112	170
24	11	206000212	170
25	9	206000312	170
30	9	206000412	184
36.5	7	206000512	196
39.5	7	206000612	199
125 x 100			
20	12	206000113	196
24	10	206000213	196
25	8	206000313	196
30	8	206000413	203
36.5	6	206000513	213
39.5	6	206000613	223
125 x 125			
20	12	206000114	209
24	10	206000214	209
25	8	206000314	209
30	8	206000414	221
36.5	6	206000514	237
39.5	6	206000614	248

Plastic window insert: ZO-MDK – tilt & turn

High-quality plastic window with installations depths of 58 mm or 70 mm, offset surfaces with double window rebate seals, Insulating glass Ug 1.1 W/m²K and safety one-hand tilt & turn profile Roto NX with increased security owed to the mushroom pin lock. Available as tilt & turn DIN right, DIN left. Standard consignment is DIN right unless indicated differently. For basements or quality spare rooms.



Color(s):



white

Type ZO-MDK
Tilt & turn sash DIN right

Accessories for casement windows see pages 36-38.

! Special dimensions such as 50 x 100 or 75 x 100 cm upon request.

! Double sash window possible from a width of 125 cm. Tilt & turn / tilt & turn

58 mm installation depth

Casement size in cm (W x H)	Visible glass pane m ²	Item number R	Item number L	Price €
75 x 50	0.09	208020101	208020115	226
75 x 62.5	0.15	208020102	208020116	235
75 x 75	0.21	208020103	208020117	260
87.5 x 50	0.12	208020104	208020118	240
87.5 x 62.5	0.19	208020105	208020119	261
87.5 x 75	0.26	208020106	208020120	268
100 x 50	0.14	208020107	208020121	261
100 x 62.5	0.23	208020108	208020122	267
100 x 75	0.32	208020109	208020123	283
100 x 100	0.50	208020110	208020124	319
125 x 62.5	0.31	208020111	208020125	326
125 x 75	0.43	208020112	208020126	369
125 x 100	0.67	208020113	208020127	408
125 x 125	0.91	208020114	208020128	469

70 mm installation depth

Casement size in cm (W x H)	Visible glass pane m ²	Item number R	Item number L	Price €
75 x 50	0.09	208025101	208025115	245
75 x 62.5	0.15	208025102	208025116	261
75 x 75	0.20	208025103	208025117	278
87.5 x 50	0.11	208025104	208025118	261
87.5 x 62.5	0.19	208025105	208025119	278
87.5 x 75	0.26	208025106	208025120	295
100 x 50	0.14	208025107	208025121	279
100 x 62.5	0.23	208025108	208025122	295
100 x 75	0.31	208025109	208025123	312
100 x 100	0.49	208025110	208025124	349
125 x 62.5	0.31	208025111	208025125	373
125 x 75	0.42	208025112	208025126	403
125 x 100	0.66	208025113	208025127	425
125 x 125	0.90	208025114	208025128	501

! Double sash:

125 x 62.5	0.26	208025129	510
125 x 75	0.36	208025130	545
125 x 100	0.56	208025131	574
125 x 125	0.76	208025132	604

Triple-paned insulating window for 70 mm installation depth:

(Triple-paned Ug 0.7 W/m²K insulating window for an installation depth of 70 mm, glass design 4/12/4/12/4 mm).

Surcharge €18 per sash for all sizes

Plastic window insert: ZO-PLUS – tilt

High-quality plastic window insert with an installation depth of 58 mm, sash with patented corner joints. Simple glass retrofit possible. For basements and central heating rooms.



Color(s):



white



brown
(7% surcharge)

Type ZO-PLUS with single pane
Type ZO-PLUS with insulating glass
Hopper sash (tilt) insert

Accessories for casement windows see pages 36-38.

! Galvanized grille only for single pane and insulating glass 15 mm.

! Special dimensions such as 50 x 100 or 75 x 100 cm upon request.

! Third lock top center included for widths of 125 cm and wider!

58 mm installation depth

Casement size in cm / glass	Visible glass pane m ²	Item number white	Item number brown	Price € white
75 x 50				
Single pane 5 mm	0.13	208005101	208005201	76
Insulated glass 15 mm	0.13	208006101	208006201	92
Insulating glass Ug 1.2	0.11	208008101	208008201	106
Galvanized grille	-	208007101	208007101	34
75 x 62.5				
Single pane 5 mm	0.19	208005102	208005202	87
Insulated glass 15 mm	0.19	208006102	208006202	106
Insulating glass Ug 1.2	0.18	208008102	208008202	116
Galvanized grille	-	208007102	208007102	39
75 x 75				
Single pane 5 mm	0.26	208005103	208005203	92
Insulated glass 15 mm	0.26	208006103	208006203	116
Insulating glass Ug 1.2	0.24	208008103	208008203	128
Galvanized grille	-	208007103	208007103	45
87.5 x 50				
Single pane 5 mm	0.16	208005104	208005204	88
Insulated glass 15 mm	0.16	208006104	208006204	107
Insulating glass Ug 1.2	0.14	208008104	208008204	117
Galvanized grille	-	208007104	208007104	40
87.5 x 62.5				
Single pane 5 mm	0.24	208005105	208005205	93
Insulated glass 15 mm	0.24	208006105	208006205	117
Insulating glass Ug 1.2	0.22	208008105	208008205	130
Galvanized grille	-	208007105	208007105	46

Casement size in cm / glass	Visible glass pane m ²	Item number white	Item number brown	Price € white
87.5 x 75				
Single pane 5 mm	0.32	208005106	208005206	106
Insulated glass 15 mm	0.32	208006106	208006206	127
Insulating glass Ug 1.2	0.30	208008106	208008206	145
Galvanized grille	-	208007106	208007106	50
100 x 50				
Single pane 5 mm	0.19	208005107	208005207	95
Insulated glass 15 mm	0.19	208006107	208006207	117
Insulating glass Ug 1.2	0.17	208008107	208008207	130
Galvanized grille	-	208007107	208007107	39
100 x 62.5				
Single pane 5 mm	0.29	208005108	208005208	105
Insulated glass 15 mm	0.29	208006108	208006208	126
Insulating glass Ug 1.2	0.27	208008108	208008208	144
Galvanized grille	-	208007108	208007108	48
100 x 75				
Single pane 5 mm	0.38	208005109	208005209	112
Insulated glass 15 mm	0.38	208006109	208006209	149
Insulating glass Ug 1.2	0.36	208008109	208008209	164
Galvanized grille	-	208007109	208007109	53
100 x 100				
Single pane 5 mm	0.57	208005110	208005210	132
Insulated glass 20 mm	0.57	208006110	208006210	178
Insulating glass Ug 1.2	0.54	208008110	208008210	203
Galvanized grille	-	208007110	208007110	69

Plastic window insert: ZO-PLUS – tilt

High-quality plastic window insert with an installation depth of 58 mm, sash with patented corner joints. Simple glass retrofit possible. For basements and central heating rooms.



Color(s):



white



brown
(7% surcharge)

Type ZO-PLUS with single pane
Type ZO-PLUS with insulating glass
Hopper sash (tilt) insert

Accessories for casement windows see pages 36-38.

! Galvanized grille only for single pane and insulating glass 15 mm.

! Special dimensions such as 50 x 100 or 75 x 100 cm upon request.

! Third lock top center included for widths of 125 cm and wider!

58 mm installation depth

Casement size in cm / glass	Visible glass pane m ²	Item number white	Item number brown	Price € white
125 x 62.5				
Single pane 5 mm	0.38	208005111	208005211	124
Insulated glass 20 mm	0.38	208006111	208006211	162
Insulating glass Ug 1.2	0.36	208008111	208008211	176
Galvanized grille	-	208007111	208007111	57
125 x 75				
Single pane 5 mm	0.51	208005112	208005212	133
Insulated glass 20 mm	0.51	208006112	208006212	174
Insulating glass Ug 1.2	0.48	208008112	208008212	199
Galvanized grille	-	208007112	208007112	68

Casement size in cm / glass	Visible glass pane m ²	Item number white	Item number brown	Price € white
125 x 100				
Single pane 5 mm	0.76	208005113	208005213	171
Insulated glass 20 mm	0.76	208006113	208006213	202
Insulating glass Ug 1.2	0.73	208008113	208008213	232
Galvanized grille	-	208007113	208007113	91
125 x 125				
Single pane 5 mm	1.01	208005114	208005214	202
Insulated glass 20 mm	1.01	208006114	208006214	222
Insulating glass Ug 1.2	0.97	208008114	208008214	248
Galvanized grille	-	208007114	208007114	112

1
2
3
4
5
6
7
8
9
10
11
12
13
14
15
16
17
18

Plastic window insert: ZO-TOP – tilt

High-quality plastic window with installations depths of 58 mm or 70 mm, offset surfaces with double window rebate seals and hidden tilt fittings completely made of plastic, elegant and stable window handles, mounting screws of stainless steel V2A. All types with insulating glass Ug 1.1 W/m²K (total depth of 24 mm). For utility rooms, garages and agricultural buildings.



Color(s):



white

Type ZO-TOP
Hopper sash (tilt) insert

Accessories for casement windows see pages 36-38.

! Special dimensions such as 50 x 100 or 75 x 100 cm upon request.

! Third lock top center included for widths of 125 cm and wider!

58 mm installation depth

Casement size in cm (W x H)	Visible glass pane m ²	Item number	Price €
75 x 50	0.09	208030101	168
75 x 62.5	0.15	208030102	184
75 x 75	0.21	208030103	198
87.5 x 50	0.12	208030104	184
87.5 x 62.5	0.19	208030105	188
87.5 x 75	0.26	208030106	203
100 x 50	0.14	208030107	188
100 x 62.5	0.23	208030108	194
100 x 75	0.32	208030109	208
100 x 100	0.50	208030110	223
125 x 62.5	0.31	208030111	221
125 x 75	0.43	208030112	235
125 x 100	0.67	208030113	251
125 x 125	0.91	208030114	264

70 mm installation depth

Casement size in cm (W x H)	Visible glass pane m ²	Item number	Price €
75 x 50	0.09	208035101	182
75 x 62.5	0.15	208035102	198
75 x 75	0.20	208035103	213
87.5 x 50	0.11	208035104	198
87.5 x 62.5	0.19	208035105	202
87.5 x 75	0.26	208035106	217
100 x 50	0.14	208035107	202
100 x 62.5	0.23	208035108	209
100 x 75	0.31	208035109	226
100 x 100	0.49	208035110	242
125 x 62.5	0.31	208035111	239
125 x 75	0.42	208035112	255
125 x 100	0.66	208035113	269
125 x 125	0.90	208035114	285

Triple-paned insulating window for 70 mm installation depth:

(Triple-paned Ug 0.7 W/m²K insulating window for an installation depth of 70 mm, glass design 4/12/4/12/4 mm).

Surcharge €18 per sash for all sizes

Plastic window insert: ZO-FIB – fixed window pane

High-quality plastic window with installations depths of 58 mm or 70 mm and insulating glass Ug 1.1 W/m²K. For basements, industry and agricultural buildings.



Color(s):



Type ZO-FIB
Fixed window pane

Accessories for casement windows see pages 36-38.

! Special dimensions such as 50 x 100 or 75 x 100 cm upon request.

58 mm installation depth

Casement size in cm (W x H)	Visible glass pane m ²	Item number	Price €
75 x 50	0.15	208040101	147
75 x 62.5	0.22	208040102	153
75 x 75	0.29	208040103	165
87.5 x 50	0.19	208040104	155
87.5 x 62.5	0.27	208040105	167
87.5 x 75	0.35	208040106	171
100 x 50	0.22	208040107	165
100 x 62.5	0.32	208040108	170
100 x 75	0.42	208040109	184
100 x 100	0.62	208040110	197
125 x 62.5	0.43	208040111	186
125 x 75	0.56	208040112	197
125 x 100	0.81	208040113	211
125 x 125	1.07	208040114	217

70 mm installation depth

Casement size in cm (W x H)	Visible glass pane m ²	Item number	Price €
75 x 50	0.15	208045101	158
75 x 62.5	0.22	208045102	164
75 x 75	0.28	208045103	180
87.5 x 50	0.18	208045104	167
87.5 x 62.5	0.27	208045105	181
87.5 x 75	0.35	208045106	188
100 x 50	0.22	208045107	180
100 x 62.5	0.32	208045108	187
100 x 75	0.41	208045109	197
100 x 100	0.61	208045110	211
125 x 62.5	0.42	208045111	199
125 x 75	0.55	208045112	211
125 x 100	0.80	208045113	229
125 x 125	1.06	208045114	237

Triple-paned insulating window for 70 mm installation depth:

(Triple-paned Ug 0.7 W/m²K insulating window for an installation depth of 70 mm, glass design 4/12/4/12/4 mm).

Surcharge €18 per sash for all sizes

Cast iron basement window insert: ZO-SD1 and ZO-SD2

Sturdy basement window with side-hung glass sash and side-hung grille.

Single 5-mm safety glass pane. Single sash up to a width of 87.5 cm, double sash from a width of 100 cm.

Available galvanized or powder-coated; we deliver galvanized unless indicated otherwise.

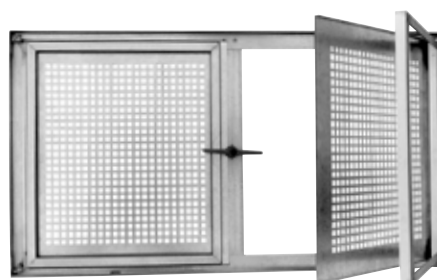

Color/s: powder-coated

 traffic white
RAL 9016

 sepia brown
RAL 8014

 light grey
RAL 7035

Type ZO-SD2

Glass and grille sash can be opened, galvanized

ZO-SD

Casement sizes in cm (W x H) Grille variants	Item number	Price €
75 x 50		
Galvanized	208009101	117
Powder-coated*	208009201	upon request!
75 x 62.5		
Galvanized	208009102	134
Powder-coated**	208009202	upon request!
75 x 75		
Galvanized	208009103	152
Powder-coated*	208009203	upon request!
87.5 x 50		
Galvanized	208009104	136
Powder-coated*	208009204	upon request!
87.5 x 62.5		
Galvanized	208009105	153
Powder-coated*	208009205	upon request!

Casement sizes in cm (W x H) Grille variants	Item number	Price €
87.5 x 75		
Galvanized	208009106	178
Powder-coated*	208009206	upon request!
100 x 50		
Galvanized	208009107	151
Powder-coated*	208009207	upon request!
100 x 62.5		
Galvanized	208009108	175
Powder-coated*	208009208	upon request!
100 x 75		
Galvanized	208009109	200
Powder-coated*	208009209	upon request!
100 x 100		
Galvanized	208009110	243
Powder-coated*	208009210	upon request!

Casement sizes in cm (W x H) Grille variants	Item number	Price €
125 x 62.5		
Galvanized	208009111	213
Powder-coated*	208009211	upon request!
125 x 75		
Galvanized	208009112	227
Powder-coated*	208009212	upon request!
125 x 100		
Galvanized	208009113	289
Powder-coated*	208009213	upon request!

Custom-made WOLFA – products

! Customized sizes such as 50 x 100 or 75 x 100 cm possible.

Accessories for casement windows see pages 36 to 38.

Cast iron basement window insert: ZO-SF1 and ZO-SF2

Sturdy basement window with side-hung glass sash and fixed grille.

Single 5-mm safety glass pane. Single sash up to a width of 87.5 cm, double sash from a width of 100 cm.

Available galvanized or powder-coated; we deliver galvanized unless indicated otherwise.

Color/s: powder-coated*

 traffic white
RAL 9016

 sepia brown
RAL 8014

 light grey
RAL 7035

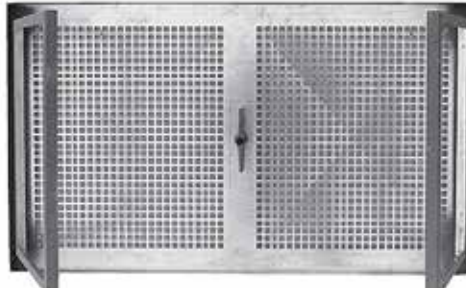

Type SF will be discontinued!

Type ZO-SF2

Fixed grille, side-hung glass sash can be opened, galvanized

ZO-SF

Casement sizes in cm (W x H) Grille variants	Item number	Price €
75 x 50		
Galvanized	208011101	89
Powder-coated*	208011201	upon request!
75 x 62.5		
Galvanized	208011102	95
Powder-coated*	208011202	upon request!
75 x 75		
Galvanized	208011103	114
Powder-coated*	208011203	upon request!
87.5 x 50		
Galvanized	208011104	97
Powder-coated*	208011204	upon request!
87.5 x 62.5		
Galvanized	208011105	115
Powder-coated*	208011205	upon request!

Casement sizes in cm (W x H) Grille variants	Item number	Price €
87.5 x 75		
Galvanized	208011106	120
Powder-coated*	208011206	upon request!
100 x 50		
Galvanized	208011107	112
Powder-coated*	208011207	upon request!
100 x 62.5		
Galvanized	208011108	118
Powder-coated*	208011208	upon request!
100 x 75		
Galvanized	208011109	130
Powder-coated*	208011209	upon request!
100 x 100		
Galvanized	208011110	163
Powder-coated*	208011210	upon request!

Casement sizes in cm (W x H) Grille variants	Item number	Price €
125 x 62.5		
Galvanized	208011111	139
Powder-coated*	208011211	upon request!
125 x 75		
Galvanized	208011112	152
Powder-coated*	208011212	upon request!
125 x 100		
Galvanized	208011113	187
Powder-coated*	208011213	upon request!

Custom-made WOLFA – products

! Customized sizes such as 50 x 100 or 75 x 100 cm possible.

Accessories for casement windows see pages 36 to 38.

Casement windows: Options

Picture	Description	Item number	Price €
	Lockable RAL-certified window handle	209020800	58
	Dryer connection NW 100 for ZO-PLUS	209005400	70
	for ZO-MDK, ZO-FIB, ZO-TOP for 70 and 82 mm installation depth	209020400	167
	Forced ventilation section Permanent ventilation in central heating rooms	209020500	
	for ZO-PLUS	209005500	42
	External window sill for types ZO and ZOW		
	75 cm	209000101	24
	87.5 cm	209000104	30
	100 cm	209000107	31
	125 cm	209000111	35

Casement windows: anti burglary kit

The anti burglary kit comprises Steel fittings in window casing and sash for 70 and 82 profiles, anti-drill protection, additional safety lock elements, laminated safety glass (6 VSG/14/4) Ug 1.1 and a lockable window handle.

	Casement size in cm (W x H)	Item number	Price €
	75 x 50	209025201	118
	75 x 62.5	209025202	122
	75 x 75	209025203	136
	87.5 x 50	209025204	128
	87.5 x 62.5	209025205	139
	87.5 x 75	209025206	146
	100 x 50	209025207	132
	100 x 62.5	209025208	144
	100 x 75	209025209	153
	100 x 100	209025210	171
	125 x 62.5	209025211	165
	125 x 75	209025212	184
125 x 100	209025213	214	
125 x 125	209025214	249	

Casement windows: Perimeter masking

Fits all casement window types. Insulation thicknesses: 6 - 12 cm and 12 - 20 cm



Casement size in cm / Insulation depth in cm	Item number	Price €	Casement size in cm / Insulation depth in cm	Item number	Price €	Casement size in cm / Insulation depth in cm	Item number	Price €
75 x 50			87.5 x 75			125 x 62.5		
6-12	209000501	39	6-12	209000506	46	6-12	209000510	48
12-20	209000601	68	12-20	209000606	87	12-20	209000611	99
75 x 62.5			100 x 50			125 x 75		
6-12	209000502	40	6-12	209000507	45	6-12	209000511	53
12-20	209000602	70	12-20	209000607	82	12-20	209000612	104
75 x 75			100 x 62.5			125 x 100		
6-12	209000503	42	6-12	209000508	46	6-12	209000513	58
12-20	209000603	77	12-20	209000608	88	12-20	209000613	118
87.5 x 50			100 x 75			125 x 125		
6-12	209000504	41	6-12	209000509	48	12-20	209000614	135
12-20	209000604	75	12-20	209000609	99			
87.5 x 62.5			100 x 100					
6-12	209000505	42	6-12	209000512	52			
12-20	209000605	78	12-20	209000610	104			

! Perimeter masking for insulation elements: see page 21.

! Customized to insulation thickness upon request €6.

Custom-made WOLFA – products

! Special dimensions upon request.

Casement windows: Bar grilles

Solid, hot-dipped grille made of square bars

	Casement size in cm (W x H)	Item number	Price €	Casement size in cm (W x H)	Item number	Price €
	75 x 50	209000801	85	100 x 62.5	209000808	97
75 x 62.5	209000802	86	100 x 75	209000809	99	
75 x 75	209000803	94	100 x 100	209000810	114	
87.5 x 50	209000804	88	125 x 62.5	209000811	106	
87.5 x 62.5	209000805	98	125 x 75	209000812	116	
87.5 x 75	209000806	100	125 x 100	209000813	121	
100 x 50	209000807	89	125 x 125	209000814	129	

Casement windows: Mosquito screen

Solid aluminum frame RAL 9016, powder-coated with special hinge brackets, black gauze.

	Casement size in cm (W x H)	Item number	Price €	Casement size in cm (W x H)	Item number	Price €
	75 x 50	209025301	182	100 x 62.5	209025308	194
75 x 62.5	209025302	187	100 x 75	209025309	200	
75 x 75	209025303	191	100 x 100	209025310	211	
87.5 x 50	209025304	187	125 x 62.5	209025311	211	
87.5 x 62.5	209025305	191	125 x 75	209025312	219	
87.5 x 75	209025306	194	125 x 100	209025313	232	
100 x 50	209025307	191	125 x 125	209025314	251	

1
2
3
4
5
6
7
8
9
10
11
12
13
14
15
16
17
18

Casement windows: Patterned glass

Minimum charged size 0.4 m² Other patterned glasses upon request

		<p>Chinchilla white</p>	<p>Item number 209000901</p>	<p>Casement size €/m² 65</p>
		<p>Pattern 504 white</p>	<p>Item number 209000901</p>	<p>Casement size €/m² 65</p>
		<p>Mastercarré white *</p>	<p>Item number 209000902</p>	<p>Casement size €/m² 92</p>
		<p>Silvit 178 white</p>	<p>Item number 209000901</p>	<p>Casement size €/m² 65</p>
		<p>Madras Uadi white</p>	<p>Item number 209000903</p>	<p>Casement size €/m² 144</p>

* For production-related reasons, the structural flow cannot be attuned to the geometrical shapes of the patterned glass frames.

Notes for planning

1

2

3

4

5

6

7

8

9

10

11

12

13

14

15

16

17

18



Multi-purpose windows

WOLFA multi-purpose windows complement your basement rooms, garages, utility rooms, agricultural buildings or living spaces and fulfill the highest design standards. From hopper windows with standard single pane or insulated glass, from tilt & turn windows with double or triple glazing and a U_w -value of $0.85 \text{ W/m}^2\text{K}$ - we manufacture them all. We supply standard and customer-tailored sizes. The vast selection of additional profiles, special glazings, safety and anti-burglary versions and color options leave nothing to desire.



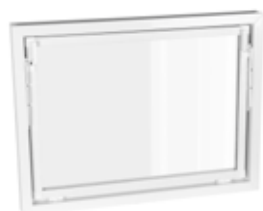

PLUS tilt

42-43



FIB fixed window pane

45



MDK tilt & turn

46



Security grille / perforated plates

47



TOP tilt

48



Klickfix/Fast snap window systems

50-55

1

2

3

4

5

6

7

8

9

10

11

12

13

14

15

16

17

18

Product information:

WOLFA hopper window „PLUS“, the perfect replacement window for brick wall installation. Plastic multi-chamber profile with an installation depth of 58 mm, hopper wing with patented corner joints, wing neither glued nor clamped, simple glass replacement.

- We provide all widths and heights from 25 cm up to a size of 125 x 100 cm
- Interface profiles allow seamless connection of any number of windows next or above each other.



Type PLUS with 5-mm single pane
Type PLUS with 15-mm insulated glass
Type PLUS with 20-mm insulated glass

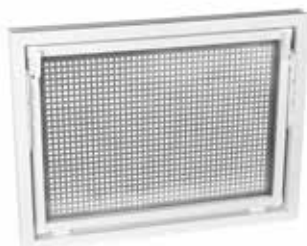

Type PLUS with galvanized security grille (cm² hole pitch, cambered)

Intermediate sizes:

gross price for the next largest size, e.g. size 76 x 43 with single pane → such as size (Width x Height) 80 x 50 = €83

! Third lock top center included for widths of 110 cm and wider

* Model with 20 mm 3/14/3 insulating glass with security grille = 15-mm insulating glass.

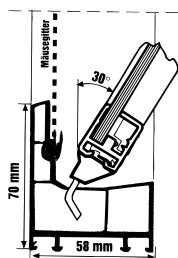

Profile cross-section Type PLUS

PLUS: standard sizes - single sash, white

Size in cm (W x H x D)	PE single pane €	PLUS with insulating glass €	Security grille €
60 x 40	59	78	34
60 x 50	60	82	35
80 x 40	68	85	37
70 x 50	70	87	37
80 x 50	72	93	40
80 x 60	78	103	46
100 x 50	82	115	46
100 x 60	89	126	56
100 x 70	93	138	62
100 x 80	101	158	71
100 x 100	116	168	89

* 20-mm insulated glass

Color(s):

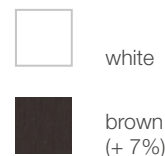

PLUS: intermediate sizes – single sash, white

Glass variants ▼	Width in cm up to ▶	Height in cm to ▼	Price €						
			50	60	70	80	90	100	120
Single pane	30	30	58	63	75	81	88	92	115
Insulated glass			71	80	89	97	110	118	145
Security grille			30	33	35	36	37	40	45
Single pane	40	40	59	68	77	82	89	94	115
Insulated glass			71	80	89	97	110	118	145
Security grille			33	34	35	37	39	40	45
Single pane	50	50	60	69	78	83	91	95	117
Insulated glass			78	83	92	99	116	124	151
Security grille			34	35	37	40	45	46	56
Single pane	60	60	70	77	83	89	98	105	127
Insulated glass			87	92	106	115	129	135	168
Security grille			35	39	41	46	50	56	64
Single pane	70	70	81	87	92	97	106	118	141
Insulated glass			95	106	118	132	140	150	174
Security grille			37	41	46	51	59	62	69
Single pane	80	80	85	91	97	106	115	120	142
Insulated glass			106	118	135	144	156	162	193
Security grille			40	45	50	57	64	72	83
Single pane	90	90	91	97	107	118	124	130	145
Insulated glass			118	134	141	155	164	169	198
Security grille			43	51	56	64	71	80	93
Single pane	100	100	95	106	117	122	128	132	147
Insulated glass			130	144	155	163	170	182	211
Security grille			46	52	63	70	80	89	104

PLUS: Special designs

	<p>Surcharge for forced ventilation sash</p> <p>Permanent ventilation in central heating rooms</p> <p>Color-coated security grilles see page 49.</p>	42
	<p>Surcharge for dryer connection</p> <p>NW 100 with slatted openings</p>	70

PLUS: patterned glass

Minimum charged size 0.4 m²

Glass variants	Outside surface €/m ²
Chinchilla	65
Silvit 178	65
Ornament 504	65
Altdeutsch K	65
Abstracto 187	65
Patterned glass – Single "raw glass" pane**	31
Wire glass 7 mm single pane	65
ESG (single-pane safety glass) 5 mm	86
VSG (laminated safety glass) 6 mm	78
Insulating glass / ESG 5 mm	94
Insulating glass / ESG 6 mm	88

* structure similar to obscure finely hammered Cathedral Glass

! Patterned glazing see page 127.

PLUS: ALU outside window sills

150-mm projection with lateral terminating elements in aluminium

A 700, 22 mm plaster. Other projections, color shades, noise suppressors, etc. are available upon request!



Length in cm up to	Color EV 1, anodized €	White, powder-coated €
50	30	35
60	37	41
70	41	43
80	46	48
90	52	54
100	54	57
120	64	66
130	70	74

PLUS: special glazing

Not available in combination with security grille!

Size in cm (W x H x D)	Ug 1.2 W/m ² K (4/12/4mm)	Ug 3.0 W/m ² K (3/14/3mm)
60 x 40	94	85
60 x 50	100	89
80 x 40	103	93
70 x 50	110	94
80 x 50	116	101
80 x 60	127	111
100 x 50	141	126
100 x 60	152	136
100 x 70	163	150
100 x 80	174	158
100 x 100	185	168
120 x 100	219	182

Intermediate sizes:

+12% surcharge on the next larger standard size

PLUS: interface profiles

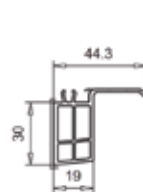

Window sill interface profile
30 mm / rm € 7



Window sill interface profile
45 mm / rm € 10

PLUS: Enlargements

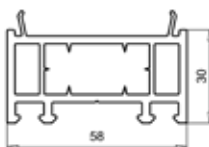

Frame enlargement
30 mm / rm € 16.30

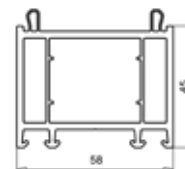

Frame enlargement
45 mm / rm € 18.70

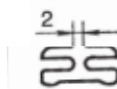

Interface profile
rm € 8

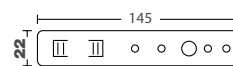

Wall anchor kit for window
fastening 4 pcs / € 4

1 Product information:

2 Multi-purpose window type MDK, plastic, white, various installation depths fulfills all requirements. The MDK „De Luxe 82“ with its U_w value of $0,85 \text{ W/m}^2\text{K}$ meets the highest demands on living comfort and guarantees significantly higher insulation values
3 than required by the EnEV 2009 standard.

4 All types come with hidden one-hand tilt & turn profile Roto NX and mushroom pin lock for increased safety and security. A solid, white powder-coated window handle is included in the consignment. Available as tilt & turn DIN right, DIN left. Standard consignment is DIN right unless indicated differently.

5 De Luxe 82

- 6 ■ Better than required by EnEV 2009
- 7 ■ 7-chamber profile, 82-mm installation depth
- 8 ■ U_w value $0,85 \text{ W/m}^2\text{K}$
- 9 ■ U_g value $0,6 \text{ W/m}^2\text{K}$
- 10 ■ Triple-pane glass with thermal edge bond
- 11 ■ Offset surfaces
- 12 ■ Available in many colors
- 13 ■ Highest living comfort

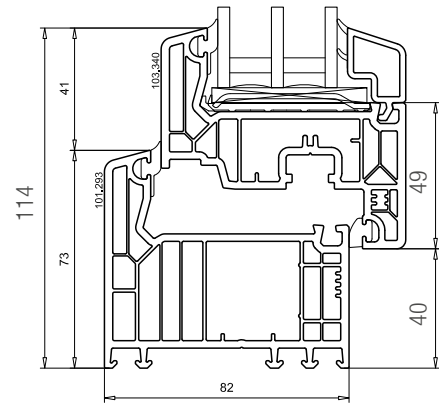
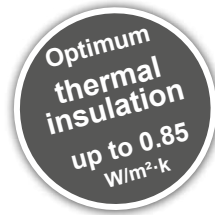

Profile cross section WOLFA MKD windows De Luxe 82 with an installation depth of 82 mm

10 De Luxe 70

- 11 ■ Complies with EnEV 2009
- 12 ■ 5-chamber profile, 70-mm installation depth
- 13 ■ Offset surfaces with double window rebate seal
- 14 ■ All types with U_g $1.1 \text{ W/m}^2\text{K}$ glazing
- 15 ■ Triple-paned insulating window U_g 0.7 W/m^2 possible
- 16 ■ Available in many colors
- 17 ■ High living comfort

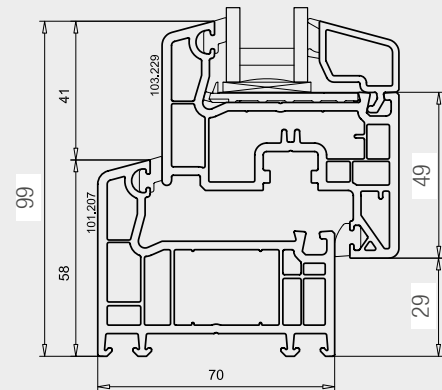

Profile cross section WOLFA MKD windows De Luxe 70 with an installation depth of 70 mm

14 Klassik 58

- 15 ■ Perfect for garages and utility rooms
- 16 ■ 3-chamber profile, 58-mm installation depth
- 17 ■ Offset surfaces with double window rebate seal
- 18 ■ All types with U_g $1.1 \text{ W/m}^2\text{K}$ glazing
- 19 ■ available in white

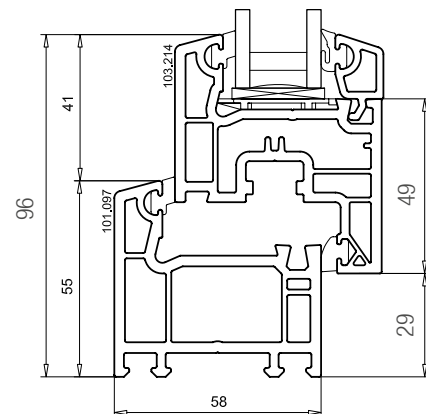
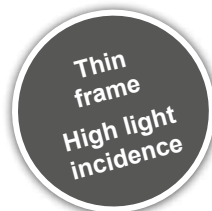

Profile cross section WOLFA MKD windows Klassik 58 with 58-mm installation depth

Product information:

High-quality profile with three, five or seven chambers, with thermal insulation glass from $U_g 1.1 \text{ W/m}^2\text{K}$ to $U_g = 0,6 \text{ W/m}^2\text{k}$. The glass is mounted directly into the window casement, i.e. no extra frame for the sash and therefore more light in your room. Color white

FIB: intermediate sizes – fixed window pane, white



Intermediate sizes:

gross price for the next largest intermediate size (width x height), e.g. FIB 58 size 86 x 53 and size 90 x 60 = €147

Types ▼	Width in cm up to ►	50	60	70	80	90	100	120
	Height in cm to ▼	Price €						
De Luxe 82	50	167	184	194	208	223	239	252
De Luxe 70		118	127	130	136	146	152	159
Klassik 58		112	121	124	129	139	145	151
De Luxe 82	60	184	200	213	229	244	261	278
De Luxe 70		127	136	140	147	155	163	171
Klassik 58		121	129	133	140	147	155	163
De Luxe 82	70	193	211	232	248	267	286	304
De Luxe 70		130	139	149	155	165	175	185
Klassik 58		124	132	141	147	157	167	175
De Luxe 82	80	205	226	248	263	284	304	325
De Luxe 70		135	145	155	162	171	180	191
Klassik 58		128	138	147	153	163	171	181
De Luxe 82	90	220	244	266	286	305	328	348
De Luxe 70		142	153	164	173	182	192	200
Klassik 58		135	146	156	164	173	182	191
De Luxe 82	100	237	263	286	305	330	351	376
De Luxe 70		151	164	175	184	194	203	215
Klassik 58		144	156	167	174	185	193	204

FIB 70 fixed window pane Surcharge triple-paned glass = €18

Triple-paned insulating glass:

De Luxe 70: Glass design /4/12/4/12/4 mm), $U_g = 0.7$

De Luxe 82: Glass design /4/16/4/16/4 mm), $U_g = 0.6$

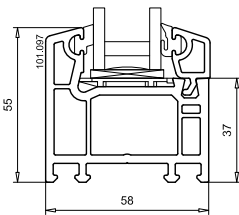

Profile cross-section FIB 58
58 mm installation depth

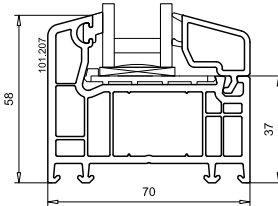

Profile cross-section FIB 70
70 mm installation depth

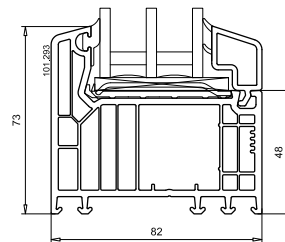

Profile cross-section FIB 82
82 mm installation depth

FIB 58 in white

Surcharge FIB 70 and 82:

One side + 15%, both sides + 25%

! Many other color foils upon request.

Color-foiled products

The following color foils/Renolit color numbers are available:



brown
8875.05



charcoal grey
87016.05



silver grey
7155.05



walnut
2178.007



mahogany
2065.021



moss green
6005.05



gob oak
2052.089



golden oak
2178.001



fir green
6125.05

1
2
3
4
5
6
7
8
9
10
11
12
13
14
15
16
17
18

Product information:
see page 44.



Type MDK plastic, white
Tilt & turn sash DIN right

MDK: Standard sizes - single sash, white

Colored windows or windows with special glazing are not standard sizes!

Size in cm (W x H)*	De Luxe 82 €	De Luxe 70 €	Klassik 58 €
80 x 50	275	245	226
80 x 60	280	250	231
90 x 60	287	258	237
100 x 50	295	263	243
100 x 60	302	269	250
100 x 80	336	298	277
100 x 100	361	325	299
120 x 100	389	347	319

* Nominal dimensions: External window dimensions 1 cm smaller, i.e. 80 x 50 cm = 79 x 49 cm
MDK De Luxe 70: Surcharge for **triple-paned glass = €18**

MDK: Intermediate sizes – single sash, white

Minimum dimensions width x height: 50.5 cm x 38.0 cm or 39.5 cm x 44.5 cm. Lower height: 38.0 cm only as tilt OR turn!



Security grilles see page 47

Types	Width in cm up to ▶	50	60	70	80	90	100	120	Price €
De Luxe 82	50	256	274	293	318	332	360	385	
De Luxe 70		227	244	252	258	264	275	304	
Klassik 58		216	232	240	245	251	262	289	
De Luxe 82	60	272	296	318	343	366	385	411	
De Luxe 70		242	257	262	267	274	287	324	
Klassik 58		229	244	249	254	261	273	308	
De Luxe 82	70	293	319	345	371	396	421	447	
De Luxe 70		245	261	267	274	285	303	331	
Klassik 58		233	248	254	261	270	287	314	
De Luxe 82	80	319	343	368	392	417	444	473	
De Luxe 70		252	263	275	285	297	315	343	
Klassik 58		240	250	262	270	283	299	326	
De Luxe 82	90	341	365	392	415	444	473	505	
De Luxe 70		263	277	287	307	318	341	355	
Klassik 58		250	263	273	291	302	324	337	
De Luxe 82	100	359	390	418	442	469	495	530	
De Luxe 70		277	289	302	315	331	347	372	
Klassik 58		263	274	287	299	314	330	354	

MDK De Luxe 70: Surcharge for **triple-paned glass = €18**

Color-foiled products

The following color foils/Renolit color numbers are available:

Surcharge: MDK De Luxe 82/70:

One side + 15%, both sides + 25%

! Many other color foils upon request.

! MDK Klassik 58 available in white only



brown
8875.05



charcoal grey
87016.05



silver grey
7155.05



walnut
2178.007



mahogany
2065.021



moss green
6005.05



gob oak
2052.089



golden oak
2178.001



fir green
6125.05

Multi-purpose window security grilles / perforated plates

Perforated plates / security grilles

1.5 mm, galvanized, with square centimeter hole pitch, straight rows, cambered or plane



Security grille, cambered, max. size: 117 x 249 cm.

Width in cm up to ▶	40	50	60	70	80	90	100	120
Height in cm up to ▼	Price €							
20	35	36	39	40	41	42	46	51
30	36	37	40	41	42	45	48	53
40	37	39	41	42	46	50	57	64
50	39	41	45	50	52	57	66	69
60	41	45	50	53	58	64	72	81
70	42	50	53	58	66	72	92	95
80	46	52	58	66	72	83	103	106
90	50	57	64	72	83	95	112	118
100	57	66	72	92	104	112	117	126

! Price for bulk orders upon request.

Color-coated*

Custom-made WOLFA – products

! Other widths and hole pitches possible. Prices upon request.

Outside window surface up to	Surcharge for coating €
0,5 m ²	47
0,75 m ²	48
1,0 m ²	50
1,25 m ²	51

* setup costs for up to 10 pcs
€48 net per color

Standard RAL colors:



traffic white
RAL 9016



light grey
RAL 7035



charcoal grey
RAL 7016



sepia brown
RAL 8014

! Other RAL colors upon request

Perforated plates / security grilles

Prices upon request.

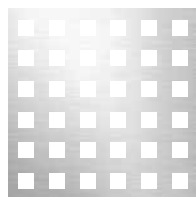

Square perforation straight row = standard perforation

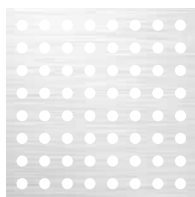

Round perforation straight row

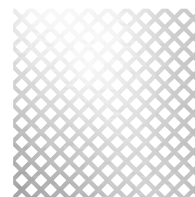

Square perforation upside down

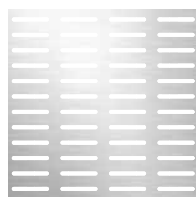

Rectangular perforation round edges

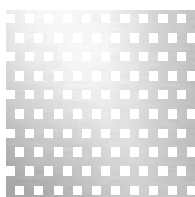

Square perforation offset rows



Round perforation offset rows

Product information:

The perfect window for agricultural buildings and all utility rooms. Particular advantages:

- Plastic hopper sash window (bottom-hinged)
- 58 mm or 70 mm installation depth (see profile cross sections multi-purpose windows MDK page 48)
- Double window rebate seals
- Hidden tilt fittings completely made of plastic
- Mounting screws made of stainless V2A steel
- All types with insulating glass Ug 1.1 W/m²K (total depth of 24 mm)



TOP: Single sash, white

We produce all sizes from a width and height of 40 cm, e.g. 93 x 46 cm = next largest suitable size 100 x 50 cm = €206 or €219.

Types ▼	Width in cm up to ►	40	50	60	70	80	90	100	110	120	130
		Price €									
TOP 58	40	162	167	174	184	188	192	200	214	220	226
TOP 70		170	174	186	194	200	206	214	227	234	240
TOP 58	50	167	174	182	188	190	199	206	220	226	232
TOP 70		176	186	193	200	206	213	219	234	240	246
TOP 58	60	174	182	188	193	203	206	213	226	233	243
TOP 70		186	193	200	208	215	219	227	240	249	258
TOP 58	70	182	188	193	204	209	214	220	233	242	250
TOP 70		193	200	208	216	221	229	235	249	256	266
TOP 58	80	188	192	203	209	214	220	231	243	249	258
TOP 70		200	206	215	221	229	25	244	258	264	274
TOP 58	90	192	199	206	214	220	231	234	250	258	266
TOP 70		206	213	219	229	235	244	251	266	274	283
TOP 58	100	199	206	213	220	231	235	243	256	264	273
TOP 70		213	219	227	235	244	251	258	270	281	290
TOP 58	110	206	213	217	226	235	243	249	264	270	280
TOP 70		219	227	233	242	251	258	263	281	289	298
TOP 58	120	213	217	226	234	242	251	257	270	278	287
TOP 70		227	233	242	249	257	266	274	289	296	307

! Third lock top center included for widths of 110 cm and wider

! The windows can be installed next or above each other.
Prices upon request.

! Cross-section profiles: see page 44.

Color surcharge: **TOP De Luxe 70:**
One side + 15%, both sides + 25%

! Many other color foils upon request.









! MDK Klassik 58 available in white only

TOP De Luxe 70: Surcharge for triple-paned glass = € 18



Available security grilles see page 47

Color-foiled products

The following color foils/Renolit color numbers are available:

	brown 8875.05		charcoal grey 87016.05		silver grey 7155.05
	walnut 2178.007		mahogany 2065.021		moss green 6005.05
	gob oak 2052.089		golden oak 2178.001		fir green 6125.05

FIB, TOP & MDK: Special designs

	<p>Surcharge for forced ventilation sash</p> <p>Permanent ventilation in central heating rooms</p> <p>*for 70 mm and 82 mm installation depth</p>	114
	<p>Surcharge for dryer connection</p> <p>NW 100 with slatted openings</p> <p>*for 70 mm and 82 mm installation depth</p>	167
	<p>Surcharge for circular cut in the insulating glass</p>	104

FIB, TOP & MDK: patterned glass

Minimum charged size 0.4 m²

Glass variants	Outside surface €/m ²
Chinchilla	65
Silvit 178	65
Ornament 504	65
Altdeutsch K	65
Abstracto 187	65
Insulating glass / ESG 5 mm (single-pane safety glass)	94
Insulating glass / VSG 6 mm (laminated safety glass)	88

! Ornament glazing samples, see page 127.

FIB, TOP & MDK: ALU outside window sills

150-mm projection with lateral terminating elements in aluminum A 700, 22 mm plaster. Other projections, color shades, noise suppression foil and sliding closures upon request!



Length in cm up to	Color EV 1, anodized €	White, powder-coated €
50	30	35
60	37	41
70	41	43
80	46	48
90	52	54
100	54	57
120	64	66
130	70	74

MDK: window handle

	<p>Surcharge for lockable window handle</p>	58
--	--	----

WOLFA anti burglary kit

	<p>Steel fittings in casement and sash, only for profile systems 70 and 82, additional safety lock elements, lockable window handle, laminated safety glass (VSG) 6 mm</p> <p>Prices upon request!</p>
--	--

FIB, TOP & MDK: interface profiles

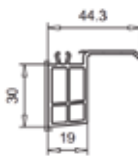

Window sill interface profile 30 mm / rm € 7.00

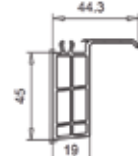

Window sill interface profile 45 mm / rm €10.00



Interface profile rm €8

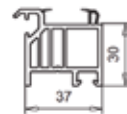

Window sill interface profile for new buildings 30 mm / rm €12.50

FIB, TOP & MDK: Enlargements

Multi-purpose window Klassik 58

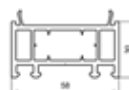

Casement enlargement 30 mm / rm €16.30

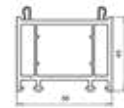

Casement enlargement 45 mm / rm €18.70

Multi-purpose window de Luxe 70

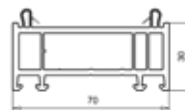

Casement enlargement 30 mm / rm €21

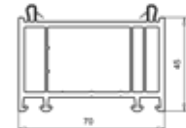

Casement enlargement 45 mm / rm €22.50

Multi-purpose window de Luxe 82

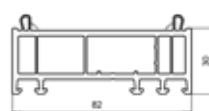

Casement enlargement 30 mm / rm €22.50

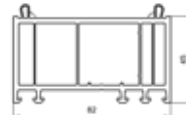

Casement enlargement 45 mm / rm €23.70

Product information:

The perfect window solution for sandwich panel walls with thicknesses of 50 to 105 mm. Fast and easy installation thanks to the click-in system. Three-chamber snap-in frame of high impact resistant PVC, installation depth 58 mm with various sash variants and variable counterbrackets that click into the casement groove. Color white.

**Discount
on Klickfix**



Klickfix 58 – FIB

Single sash window with counterbracket, fixed window pane, WOLFA-Therm® insulating glass Ug 1.1 (24 mm).

Item number: 401001...

Width in cm up to ▶	Item no.	49	Item no.	61.5	Item no.	74	Item no.	86.5	Item no.	99	Item no.	111.5	Item no.	124
Height in cm up to ▼	Price €													
49	...001	157	...008	163	...015	171	...022	180	...029	186	...036	191	...043	197
61.5	...002	163	...009	169	...016	176	...023	185	...030	191	...037	197	...044	203
74	...003	171	...010	176	...017	184	...024	192	...031	199	...038	203	...045	210
86.5	...004	180	...011	185	...018	192	...025	205	...032	210	...039	216	...046	223
99	...005	186	...012	191	...019	199	...026	210	...033	216	...040	221	...047	231
111.5	...006	191	...013	197	...020	203	...027	216	...034	221	...041	229	...048	235
124	...007	197	...014	203	...021	210	...028	223	...035	231	...042	235	...049	243

Width in cm up to ▶	Item no.	136.5	Item no.	149	Item no.	161.5	Item no.	174	Item no.	186.5	Item no.	199
Height in cm up to ▼	Price €											
49	...050	205	...057	214	...064	232	...071	244	...078	251	...085	260
61.5	...051	214	...058	231	...065	244	...072	254	...079	267	...086	277
74	...052	228	...059	242	...066	252	...073	264	...080	283	...087	296
86.5	...053	240	...060	251	...067	262	...074	279	...081	293	...088	312
99	...054	252	...061	266	...068	280	...075	298	...082	309	...089	328
111.5	...055	267	...062	283	...069	299	...076	312	...083	336	...090	355
124	...056	285	...063	302	...070	315	...077	341	...084	359	...091	380

Customer-tailored sizes and models upon request!.

Klickfix 58 – PLUS

**Discount
on Klickfix**

Single sash window with counterbrackets and hopper sash insert type PLUS,
20 mm insulated glass (3/14/3 mm) Ug 3.0.

Surcharge for insulating glass 20 mm, UG 1.2: +12% on the gross price

Item number: 401002...

Width in cm up to ▶	Item no.	49	Item no.	61.5	Item no.	74	Item no.	86.5	Item no.	99	Item no.	111.5	Item no.	124
Height in cm up to ▼	Price €													
49	...001	163	...008	169	...015	180	...022	186	...029	192	...036	198	...043	203
61.5	...002	169	...009	176	...016	184	...023	191	...030	198	...037	203	...044	209
74	...003	180	...010	184	...017	190	...024	199	...031	205	...038	209	...045	216
86.5	...004	186	...011	191	...018	199	...025	211	...032	216	...039	223	...046	231
99	...005	192	...012	198	...019	205	...026	216	...033	223	...040	229	...047	237
111.5	...006	198	...013	203	...020	209	...027	223	...034	229	...041	235	...048	243
124	...007	203	...014	209	...021	216	...028	231	...035	237	...042	243	...049	249

Customer-tailored sizes and models upon request!.

! Please indicate the circumferential dimensions in unfinished state / hole size minus approx. 1 cm.

Klickfix 58 – TOP

Single sash window with counterbrackets and hopper sash insert type TOP,
WOLFA- Therm® insulating glass Ug 1.1 (24 mm).

Item number: 401003...

Width in cm up to ▶	Item no.	49	Item no.	61.5	Item no.	74	Item no.	86.5	Item no.	99	Item no.	111.5	Item no.	124
Height in cm up to ▼	Price €													
49	...001	182	...008	191	...015	198	...022	205	...029	215	...036	223	...043	231
61.5	...002	191	...009	199	...016	209	...023	215	...030	223	...037	231	...044	237
74	...003	198	...010	209	...017	217	...024	225	...031	232	...038	238	...045	246
86.5	...004	205	...011	215	...018	225	...025	234	...032	246	...039	252	...046	261
99	...005	215	...012	223	...019	232	...026	246	...033	254	...040	260	...047	268
111.5	...006	223	...013	231	...020	238	...027	252	...034	260	...041	275	...048	285
124	...007	231	...014	237	...021	246	...028	261	...035	268	...042	285	...049	295

Customer-tailored sizes and models upon request!.

Klickfix 58 – MDK

Single sash window with counterbrackets and tilt & turn insert type MDK,
Roto NX fittings with mushroom pin lock, WOLFA - Therm®
insulating glass Ug 1.1 (24 mm).

Item number:
401004... (window right)
401005... (window left)

Width in cm up to ▶	Item no.	49	Item no.	61.5	Item no.	74	Item no.	86.5	Item no.	99	Item no.	111.5	Item no.	124
Height in cm up to ▼	Price €													
49	...001	221	...008	229	...015	235	...022	243	...029	249	...036	258	...043	273
61.5	...002	229	...009	239	...016	248	...023	255	...030	269	...037	286	...044	299
74	...003	235	...010	248	...017	255	...024	268	...031	286	...038	298	...045	312
86.5	...004	243	...011	255	...018	268	...025	285	...032	297	...039	312	...046	328
99	...005	249	...012	269	...019	286	...026	297	...033	315	...040	327	...047	343
111.5	...006	258	...013	286	...020	298	...027	312	...034	327	...041	342	...048	354
124	...007	273	...014	299	...021	312	...028	328	...035	343	...042	354	...049	367

Customer-tailored sizes and models upon request!.

! Please indicate the circumferential dimensions in unfinished state / hole size minus approx. 1 cm.

Drawing Klickfix 58 - PLUS MDK & TOP see page 54

Product information:

The perfect window solution for sandwich and panel walls with thicknesses of 57 to 117 mm. Fast and easy installation thanks to the click-in system. Three-chamber snap-in frame of high impact resistant PVC, installation depth 70 mm with different sash variants and variable counterbrackets that click into the casement groove. Color white. Color foils upon request

**Discount
on Klickfix**

Klickfix 70 – FIB

Single sash window with counterbracket, fixed window pane, WOLFA-Therm® insulating glass Ug 1.1 (24 mm).

Item number: **401101...**

Width in cm up to ▶	Item no.	49	Item no.	61.5	Item no.	74	Item no.	86.5	Item no.	99	Item no.	111.5	Item no.	124
Height in cm up to ▼	Price €													
49	...001	173	...008	180	...015	188	...022	198	...029	204	...036	210	...043	216
61.5	...002	180	...009	186	...016	194	...023	203	...030	210	...037	216	...044	223
74	...003	188	...010	194	...017	202	...024	211	...031	220	...038	223	...045	231
86.5	...004	198	...011	203	...018	211	...025	226	...032	231	...039	238	...046	246
99	...005	204	...012	210	...019	220	...026	231	...033	238	...040	243	...047	254
111.5	...006	210	...013	216	...020	223	...027	238	...034	243	...041	252	...048	260
124	...007	216	...014	223	...021	231	...028	246	...035	254	...042	260	...049	267

Width in cm up to ▶	Item no.	136.5	Item no.	149	Item no.	161.5	Item no.	174	Item no.	186.5	Item no.	199
Height in cm up to ▼	Price €											
49	...050	226	...057	235	...064	255	...071	268	...078	277	...085	286
61.5	...051	235	...058	254	...065	268	...072	279	...079	293	...086	304
74	...052	251	...059	266	...066	278	...073	291	...080	310	...087	326
86.5	...053	264	...060	277	...067	289	...074	307	...081	322	...088	343
99	...054	278	...061	292	...068	308	...075	328	...082	341	...089	361
111.5	...055	293	...062	310	...069	330	...076	343	...083	369	...090	390
124	...056	314	...063	332	...070	347	...077	374	...084	395	...091	419

Customer-tailored sizes and models upon request!

Klickfix 70 – PLUS

Single sash window with counterbrackets and hopper sash insert type PLUS, 20-mm insulating glass Ug 3.0

Surcharge for insulating glass 20 mm, UG 1.2: +12% on the gross price

Item number: **401102...**

Width in cm up to ▶	Item no.	49	Item no.	61.5	Item no.	74	Item no.	86.5	Item no.	99	Item no.	111.5	Item no.	124
Height in cm up to ▼	Price €													
49	...001	180	...008	186	...015	198	...022	204	...029	211	...036	217	...043	223
61.5	...002	186	...009	194	...016	202	...023	210	...030	217	...037	223	...044	229
74	...003	198	...010	202	...017	209	...024	220	...031	226	...038	229	...045	238
86.5	...004	204	...011	210	...018	220	...025	233	...032	238	...039	246	...046	254
99	...005	211	...012	217	...019	226	...026	238	...033	246	...040	252	...047	261
111.5	...006	217	...013	223	...020	229	...027	246	...034	252	...041	260	...048	267
124	...007	223	...014	229	...021	238	...028	254	...035	261	...042	267	...049	274

Customer-tailored sizes and models upon request!

! Please indicate the circumferential dimensions in unfinished state / hole size minus approx. 1 cm.

Drawing Klickfix 70 - FIB see page 54

Drawing Klickfix 70 - PLUS see page 54

**Discount
on Klickfix**

Klickfix 70 – TOP

Single sash window with counterbrackets and hopper sash insert type TOP, WOLFA- Therm® insulating glass Ug 1.1 (24 mm).

Item number: **401103...**

Width in cm up to ▶	Item no.	49	Item no.	61.5	Item no.	74	Item no.	86.5	Item no.	99	Item no.	111.5	Item no.	124
Height in cm up to ▼	Price €													
49	...001	200	...008	210	...015	217	...022	226	...029	237	...036	246	...043	254
61.5	...002	210	...009	220	...016	229	...023	237	...030	246	...037	254	...044	261
74	...003	217	...010	229	...017	239	...024	248	...031	255	...038	262	...045	270
86.5	...004	226	...011	237	...018	248	...025	257	...032	270	...039	278	...046	287
99	...005	237	...012	246	...019	255	...026	270	...033	279	...040	286	...047	295
111.5	...006	246	...013	254	...020	262	...027	278	...034	286	...041	303	...048	314
124	...007	254	...014	261	...021	270	...028	287	...035	295	...042	314	...049	324

Customer-tailored sizes and models upon request!.

Klickfix 70 – MDK

Single sash window with counterbrackets and tilt & turn insert type MDK, Roto NX fittings with mushroom pin lock, WOLFA - Therm® insulating glass Ug 1.1 (24 mm).

Item number:
401104... (window right)
401105... (window left)

Width in cm up to ▶	Item no.	49	Item no.	61.5	Item no.	74	Item no.	86.5	Item no.	99	Item no.	111.5	Item no.	124
Height in cm up to ▼	Price €													
49	...001	243	...008	252	...015	260	...022	267	...029	274	...036	284	...043	301
61.5	...002	252	...009	263	...016	273	...023	280	...030	296	...037	315	...044	330
74	...003	260	...010	273	...017	280	...024	295	...031	315	...038	328	...045	343
86.5	...004	267	...011	280	...018	295	...025	314	...032	327	...039	343	...046	361
99	...005	274	...012	296	...019	315	...026	327	...033	347	...040	360	...047	377
111.5	...006	284	...013	315	...020	328	...027	343	...034	360	...041	376	...048	389
124	...007	301	...014	330	...021	343	...028	361	...035	377	...042	389	...049	403









Surcharge: **triple-paned glass = €18**

Customer-tailored sizes and models upon request!.

! Please indicate the circumferential dimensions in unfinished state / hole size minus approx. 1 cm.

Color foliations Klickfix 70 - FIB, TOP, MDK

The following color foils/Renolit color numbers are available:

	brown 8875.05		charcoal grey 87016.05		silver grey 7155.05
	walnut 2178.007		mahogany 2065.021		moss green 6005.05
	gob oak 2052.089		golden oak 2178.001		fir green 6125.05

Color surcharge: **Klickfix 70:**

One side + 15%, both sides + 25%

Drawing Klickfix 70 - PLUS MDK & TOP see page 54

1
2
3
4
5
6
7
8
9
10
11
12
13
14
15
16
17
18

Drawing: Klickfix 58 - FIB

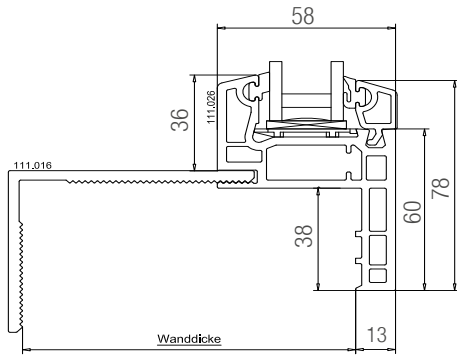

Drawing: Klickfix 70 - FIB

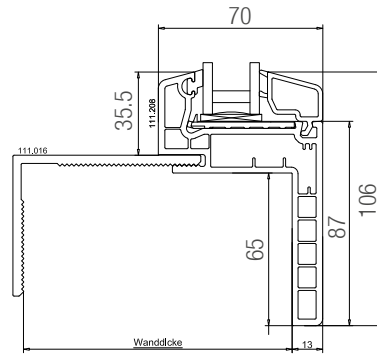

Drawing: Klickfix 58- PLUS

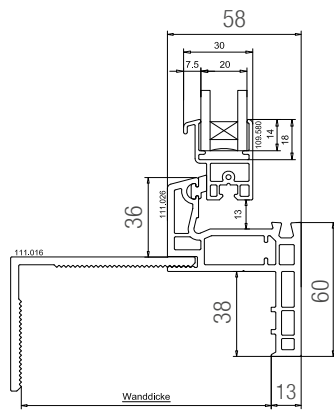

Drawing: Klickfix 70- PLUS

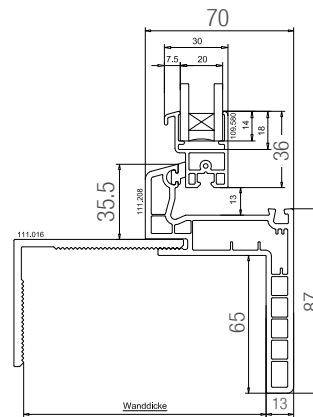

Drawing: Klickfix 58 - TOP and MDK

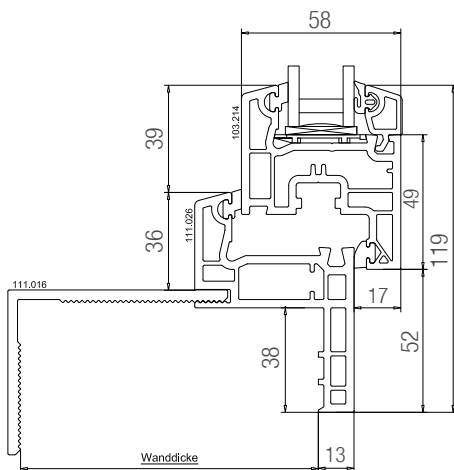

Drawing: Klickfix 70 - TOP and MDK

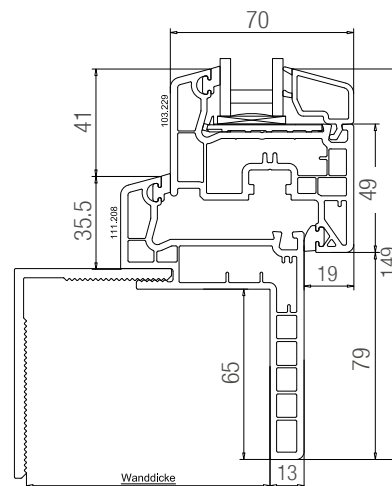

Accessories: Klickfix

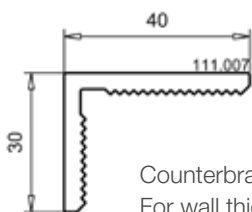

Counterbracket 30 x 40 mm
For wall thicknesses of up to 60 mm

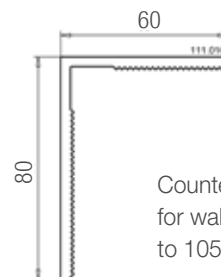

Counterbracket 60 x 80 mm
for wall thicknesses from 61mm
to 105mm / 117mm

Klickfix 1 - 2 - 3 - installed!

- 1 Place the window from the inside into the opening, align and seal.
- 2 Insert the counterbracket from the outside. The click-in system interlocks.
- 3 Use a rubber hammer to fit the counter-bracket in place. Remove the protective film.



! Find the suitable doors
on pages 110 to 111
and 121



Cast iron basement windows: SD

Single or double sash with turning grille and glass sash. Optimum anti-burglary system even when the glass sash is open.
Available DIN right or DIN left; we deliver DIN right unless indicated otherwise.
Available galvanized or powder-coated; we deliver galvanized unless indicated otherwise.

Color for powder-coating

Other colors upon request.
We deliver RAL 7035 light grey unless indicated differently.

- white
RAL 9016
- sepia brown
RAL 8014
- light grey
RAL 7035



Type SD1, single sash
Glass and grille sash can be opened

SD1 – single sash

5-mm ESG armored sheet glass

Size in cm (W x H)	Price €
50 x 30	
Galvanized	71
Powder-coated*	upon request!
50 x 40	
Galvanized	77
Powder-coated*	upon request!
50 x 50	
Galvanized	92
Powder-coated*	upon request!
60 x 30	
Galvanized	72
Powder-coated*	upon request!
60 x 40	
Galvanized	83
Powder-coated*	upon request!
60 x 50	
Galvanized	97
Powder-coated*	upon request!
60 x 60	
Galvanized	107
Powder-coated*	upon request!

Size in cm (W x H)	Price €
70 x 40	
Galvanized	94
Powder-coated*	upon request!
70 x 50	
Galvanized	109
Powder-coated*	upon request!
75 x 50	
Galvanized	112
Powder-coated*	upon request!
80 x 40	
Galvanized	100
Powder-coated*	upon request!
80 x 50	
Galvanized	123
Powder-coated*	upon request!
80 x 60	
Galvanized	142
Powder-coated*	upon request!
80 x 80	
Galvanized	163
Powder-coated*	upon request!

Size in cm (W x H)	Price €
90 x 50	
Galvanized	138
Powder-coated*	upon request!
100 x 40	
Galvanized	150
Powder-coated*	upon request!
100 x 50	
Galvanized	156
Powder-coated*	upon request!
100 x 60	
Galvanized	167
Powder-coated*	upon request!
100 x 70	
Galvanized	175
Powder-coated*	upon request!
100 x 80	
Galvanized	188
Powder-coated*	upon request!

Special sizes: 5-mm single pane.

Cast iron basement window types	Special sizes
SD1	widths between 20 and 100 cm
SD1	heights between 20 and 80 cm

! Triple sash windows, forced ventilation etc. upon request.

! **Surcharge** Wall anchor per kit (4 pcs) € 8

Price calculation special sizes:

Gross price of the next largest standard size (width and height) plus **25% surcharge.** from 10 pieces per size

Color for powder-coating

Other colors upon request.
We deliver RAL 7035 light grey unless indicated differently.

 traffic white
RAL 9016

 sepia brown
RAL 8014

 light grey
RAL 7035

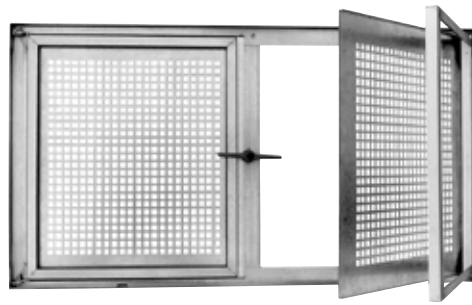

Type SD2, double sash
Glass and grille sash can be opened and unhinged, stationary center post.
Surcharge for removable center bar €11

SD2 - double sash

5-mm ESG armored sheet glass

Size in cm (W x H)	Price €
80 x 40	
Galvanized	134
Powder-coated*	upon request!
80 x 50	
Galvanized	138
Powder-coated*	upon request!
80 x 60	
Galvanized	158
Powder-coated*	upon request!
80 x 80	
Galvanized	178
Powder-coated*	upon request!
90 x 50	
Galvanized	152
Powder-coated*	upon request!
100 x 40	
Galvanized	161
Powder-coated*	upon request!
100 x 50	
Galvanized	168
Powder-coated*	upon request!

Size in cm (W x H)	Price €
100 x 60	
Galvanized	179
Powder-coated*	upon request!
100 x 70	
Galvanized	216
Powder-coated*	upon request!
100 x 80	
Galvanized	228
Powder-coated*	upon request!
100 x 100	
Galvanized	285
Powder-coated*	upon request-
110 x 100	
Galvanized	313
Powder-coated*	upon request!
120 x 100	
Galvanized	341
Powder-coated*	upon request!

Special sizes:

5-mm single pane.

Cast iron basement window types	Special sizes
SD2	all widths between 80 and 160 cm at heights up to 70 cm
SD2	all widths up to 120 cm at heights up to 100 cm

! Triple sash windows, forced ventilation etc. upon request.

! **Surcharge** Wall anchor per kit (4 pcs) € 8

Price calculation special sizes:

Gross price of the next largest standard size (width and height) plus **25% surcharge.** from 10 pieces per size

Cast iron basement windows: SF

Glass sash can be opened, stationary grille, highly effective anti burglary protection.
Available DIN right or DIN left; we deliver DIN right unless indicated otherwise.
Available galvanized or powder-coated; we deliver galvanized unless indicated otherwise.

Color for powder-coating

Other colors upon request.
We deliver RAL 7035 light grey unless indicated differently.

 traffic white
RAL 9016

 sepia brown
RAL 8014

 light grey
RAL 7035



Type SF will be discontinued!

Type SF1, single sash
Glass sash can be opened, stationary grille

SF1 – single sash

5-mm ESG armored sheet glass

Size in cm (W x H)	Price €
50 x 30	
Galvanized	69
Powder-coated*	upon request!
50 x 40	
Galvanized	71
Powder-coated*	upon request!
50 x 50	
Galvanized	89
Powder-coated*	upon request!
60 x 30	
Galvanized	69
Powder-coated*	upon request!
60 x 40	
Galvanized	81
Powder-coated*	upon request!
60 x 50	
Galvanized	93
Powder-coated*	upon request!

Size in cm (W x H)	Price €
60 x 60	
Galvanized	100
Powder-coated*	upon request!
70 x 40	
Galvanized	92
Powder-coated*	upon request!
70 x 50	
Galvanized	105
Powder-coated*	upon request!
75 x 50	
Galvanized	107
Powder-coated*	upon request!
80 x 40	
Galvanized	98
Powder-coated*	upon request!
80 x 50	
Galvanized	116
Powder-coated*	upon request!

Size in cm (W x H)	Price €
80 x 60	
Galvanized	134
Powder-coated*	upon request!

Special sizes:

5-mm single pane.

Surcharge Wall anchor per kit (4 pcs) €8

Cast iron basement window types	Special sizes
SF1	all widths between 20 and 80 cm
SF1	all heights between 20 and 80 cm

Price calculation special sizes:

Gross price of the next largest standard size (width and height) plus **25% surcharge.** from 10 pieces per size
Price calculation for XL size starting from 1.2 m²: Surface x m² price (100 x 100 cm) + 25 % surcharge

Color for powder-coating

Other colors upon request.
We deliver RAL 7035 light grey unless indicated differently.

 traffic white
RAL 9016

 sepia brown
RAL 8014

 light grey
RAL 7035

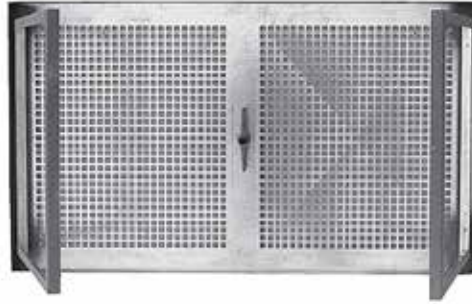

Type SF2, double sash
Glass sash can be opened and unhinged,
stationary grille

Type SF will be discontinued!

SF2 - double sash

5-mm ESG armored sheet glass

Size in cm (W x H)	Price €
80 x 40	
Galvanized	123
Powder-coated*	upon request!
80 x 50	
Galvanized	135
Powder-coated*	upon request!
80 x 60	
Galvanized	152
Powder-coated*	upon request!
90 x 50	
Galvanized	144
Powder-coated*	upon request!
100 x 40	
Galvanized	145
Powder-coated*	upon request!
100 x 50	
Galvanized	149
Powder-coated*	upon request!

Size in cm (W x H)	Price €
100 x 60	
Galvanized	171
Powder-coated*	upon request!
100 x 70	
Galvanized	200
Powder-coated*	upon request!
100 x 80	
Galvanized	217
Powder-coated*	upon request!
100 x 100	
Galvanized	275
Powder-coated*	upon request!
110 x 100	
Galvanized	301
Powder-coated*	upon request!
120 x 100	
Galvanized	326
Powder-coated*	upon request!

Special sizes:

5-mm single pane.

Cast iron basement window types	Special sizes
SF2	all widths between 80 and 160 cm at heights up to 70 cm
SF2	all widths up to 120 cm at heights up to 100 cm

Price calculation special sizes:

Gross price of the next largest standard size (width and height) plus **25% surcharge.** from 10 pieces per size
Price calculation for XL size starting from 1.2 m²: Surface x m² price (100 x 100 cm) + 25 % surcharge

Surcharge Wall anchor per kit (4 pcs) € 8



WOLFA pressure-locked gratings

The WOLFA gratings are pressure-locked according to DIN 24537 and hot-dipped according to DIN 50976 to protect against corrosion. The cross bars are force-pressed into the grooved bearing bars which run parallel to each other. The pressure-locked WOLFA gratings have significant advantages:

- the optimized grating frame profile guarantees perfect stability
- the specially developed, rounded frame profile enhances the bearing bar load capacity
- notches and cutouts do not affect the strength of frame or bearing bars



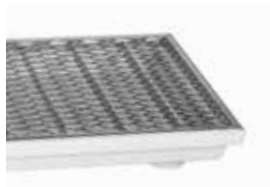

Product information 60



Shoe scraper systems 62 - 63



Garage gratings 66



Special gratings 67

Cast iron stair treads 68

according to DIN 24531

Composters / screen sieves 69

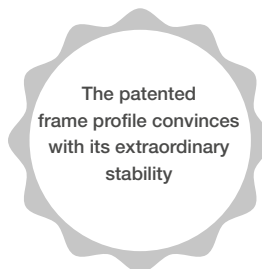

The patented frame profile convinces with its extraordinary stability

1
2
3
4
5
6
7
8
9
10
11
12
13
14
15
16
17
18

Product information:

Drip tray made of glass fiber reinforced polyester and suitable for indoor and outdoor applications, with discharge nozzle NW 70 and integrated dirt screen.

WOLFA foot scraper systems – many design possibilities

- break-proof, shock-proof, impact-proof
- all mud buckets with pressed-on drain connection ring NW 70
- easy installation
- Design without sill and barriers
- Various grating inserts, easily replaceable
- Easy cleaning thanks to the smooth and pore-free surface
- Absolutely weather-resistant

Color(s):



light grey



charcoal grey
(+ 10%)

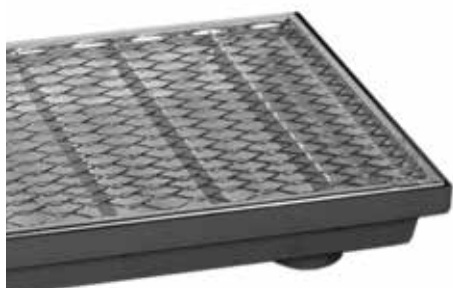

Expanded metal grating



Mats with rubber profile



Pressure-locked grating MW 30/30



Premium rep mat for indoor use



Pressure-locked grating MW 30/10



Rep mat charcoal grey with black brush inserts

Foot scraper casings and inserts

Drip tray made of glass fiber reinforced polyester and suitable for indoor and outdoor applications, with discharge nozzle NW 70 and integrated dirt screen.

GRP tray:



Size in cm (L x W x H) Design	Pieces per pallet	Item number	Price €
size 60 x 40 x 7			
without insert light grey	30	601010100	43
without insert charcoal grey	30	601020100	47.30
size 75 x 50 x 7			
without insert light grey	30	601010200	52
without insert charcoal grey	30	601020200	57.20
size 100 x 50 x 7			
without insert light grey	30	601010300	65
without insert charcoal grey	30	601020300	71.50

Angular frame

Galvanized, for doormat inserts

* with reinforcing brackets



for sizes in cm (L x W)	Size in cm (L x W x H)	Item number	Price €
60 x 40	59.8 x 39.8 x 2	602000100	18
75 x 50	74.8 x 49.8 x 2	602000200	19
100 x 50	99.8 x 49.8 x 2	602000300	22

reinforcing brackets

Reinforcing brackets for rep and rubber mats. Part of the consignment and included in the price only if purchased together with foot scraper casing! The foot scraper casing size 100 x 50 cm comes equipped with the reinforcing bracket.



for sizes in cm (L x W)	Item number	Price €
60 x 40	605010100	22
75 x 50	605010200	31



Inserts:

Installation height: 20 mm Size in cm (L x W) / Design	Item number	Price €
for size 60 x 40		
Expanded metal grating	604010100	28
Pressure-locked grating MW 30/30	604020100	29
Pressure-locked grating MW 30/10	604030100	34
Rubber mat*	604040100	129
Rep mat*	604050100	118
Rep mat with brush inserts*	604060100	133
for size 75 x 50		
Expanded metal grating	604010200	34
Pressure-locked grating MW 30/30	604020200	35
Pressure-locked grating MW 30/10	604030200	47
Rubber mat*	604040200	188
Rep mat*	604050200	129
Rep mat with brush inserts*	604060200	193
for size 100 x 50		
Pressure-locked grating MW 30/30	604020300	43
Pressure-locked grating MW 30/10	604030300	63
Rubber mat*	604040300	213
Rep mat*	604050300	149
Rep mat with brush inserts*	604060300	219

1 **Standard gratings: Gratings MW 30/30**

Grating mesh size 30 x 30 mm.



! Note:

External grating dimensions: approx. 10 mm smaller than the external casement size.

The smaller, underlined measure is the bearing bar measure.

Please indicate BB x CB in mm.

(**BB** = bearing bar, **CB** = cross bar)

! Mixed pallets possible

8 **Grating without frame**

External casement size in mm	Delivery times	Pieces per pallet	€/ pc.	
Installation height 20 mm				
<u>350</u> x 500	A	50	30	
<u>400</u> x 600	A		35	
<u>400</u> x 700	A		41	
<u>400</u> x 800	A		43	
<u>500</u> x 800	A		52	
<u>400</u> x 900	A		50	
<u>500</u> x 900	A		60	
<u>400</u> x 1000	A		54	
<u>500</u> x 1000	A		66	
<u>400</u> x 1100	B		66	
<u>500</u> x 1100	B		72	
Installation height 25 mm				
<u>500</u> x 800	A		50	62
<u>600</u> x 800	A			72
<u>500</u> x 900	A	65		
<u>600</u> x 900	A	81		
<u>500</u> x 1000	A	72		
<u>600</u> x 1000	A	87		
<u>500</u> x 1100	B	86		
<u>600</u> x 1100	B	91		
<u>500</u> x 1200	B	89		
<u>600</u> x 1200	B	94		
Installation height 30 mm				
<u>500</u> x 1000	A	50		83
<u>600</u> x 1000	A			93
<u>500</u> x 1100	B			92
<u>600</u> x 1100	B		112	
<u>500</u> x 1200	B		94	
<u>600</u> x 1200	B		117	

8 **Grating with frame**

External casement size in mm	Delivery times	Pieces per pallet	€/ pc.	
Installation height 20 mm				
<u>350</u> x 500	A	50	48	
<u>400</u> x 600	A		53	
<u>400</u> x 700	A		59	
<u>400</u> x 800	A		61	
<u>500</u> x 800	A		73	
<u>400</u> x 900	A		71	
<u>500</u> x 900	A		81	
<u>400</u> x 1000	A		75	
<u>500</u> x 1000	A		89	
<u>400</u> x 1100	B		89	
<u>500</u> x 1100	B		95	
Installation height 25 mm				
<u>500</u> x 800	A		50	83
<u>600</u> x 800	A			95
<u>500</u> x 900	A	88		
<u>600</u> x 900	A	104		
<u>500</u> x 1000	A	96		
<u>600</u> x 1000	A	111		
<u>500</u> x 1100	B	110		
<u>600</u> x 1100	B	116		
<u>500</u> x 1200	B	114		
<u>600</u> x 1200	B	119		
Installation height 30 mm				
<u>500</u> x 1000	A	50		107
<u>600</u> x 1000	A			118
<u>500</u> x 1100	B			117
<u>600</u> x 1100	B		140	
<u>500</u> x 1200	B		122	
<u>600</u> x 1200	B		145	

8 **Frame only**

External casement size in mm	Delivery times	Pieces per pallet	€/ pc.	
Installation height 20 mm				
<u>350</u> x 500	A	50	18	
<u>400</u> x 600	A		18	
<u>400</u> x 700	A		18	
<u>400</u> x 800	A		18	
<u>500</u> x 800	A		21	
<u>400</u> x 900	A		21	
<u>500</u> x 900	A		21	
<u>400</u> x 1000	A		21	
<u>500</u> x 1000	A		23	
<u>400</u> x 1100	B		23	
<u>500</u> x 1100	B		23	
Installation height 25 mm				
<u>500</u> x 800	A		50	21
<u>600</u> x 800	A			23
<u>500</u> x 900	A	23		
<u>600</u> x 900	A	23		
<u>500</u> x 1000	A	24		
<u>600</u> x 1000	A	24		
<u>500</u> x 1100	B	24		
<u>600</u> x 1100	B	25		
<u>500</u> x 1200	B	25		
<u>600</u> x 1200	B	25		
Installation height 30 mm				
<u>500</u> x 1000	A	50		24
<u>600</u> x 1000	A			25
<u>500</u> x 1100	B			25
<u>600</u> x 1100	B		28	
<u>500</u> x 1200	B		28	
<u>600</u> x 1200	B		28	

Standard gratings: Gratings MW 30/10

Grating mesh size 30 x 10 mm.



! Note:

External grating dimensions: approx. 10 mm smaller than the external casement size.

The smaller, underlined measure is the bearing bar measure.

Please indicate BB x CB in mm.

(**BB** = bearing bar, **CB** = cross bar)

! Mixed pallets possible

Grating without frame

External casement size in mm	Delivery times	Pieces per pallet	€/ pc.
Installation height 20 mm			
350 x 500	A	50	46
300 x 600	B		46
400 x 600	A		52
400 x 700	B		65
400 x 800	A		69
500 x 800	B		91
600 x 800	A		109
400 x 900	A		81
500 x 900	B		101
400 x 1000	A		89
500 x 1000	A		109
600 x 1000	A		127
400 x 1100	B		98
500 x 1100	B		121
500 x 1200	B		130

Grating with frame

External casement size in mm	Delivery times	Pieces per pallet	€/ pc.
Installation height 20 mm			
350 x 500	A	50	64
300 x 600	B		64
400 x 600	A		70
400 x 700	B		83
400 x 800	A		87
500 x 800	B		112
600 x 800	A		130
400 x 900	A		102
500 x 900	B		122
400 x 1000	A		110
500 x 1000	A		132
600 x 1000	A		150
400 x 1100	B		121
500 x 1100	B		144
500 x 1200	B		153

Frame only

External casement size in mm	Delivery times	Pieces per pallet	€/ pc.
Installation height 20 mm			
350 x 500	A	50	18
300 x 600	B		18
400 x 600	A		18
400 x 700	B		18
400 x 800	A		18
500 x 800	B		21
600 x 800	A		21
400 x 900	A		21
500 x 900	B		21
400 x 1000	A		21
500 x 1000	A		23
600 x 1000	A		23
400 x 1100	B		23
500 x 1100	B		23
500 x 1200	B		23

Accessories: gratings MW 30/30, 30/10

Picture	Accessories for	Description	Price €
	MW 30/30 MW 30/10	2 x chain lock with bracket	14

1 Garage gratings: MW 30/30

Car trafficable. Delivery time B.

2

3



4

! Mixed pallets possible

5

Casement only

External casement size in mm	Pieces per pallet	€/pc.
Installation height 30 mm		
200 x 1000	150	23
200 x 1200		25
250 x 1000		24
250 x 1200		28

7

8

Grating with encasement

External casement size in mm	Pieces per pallet	€/pc.
Mesh size 30/30, installation height 30 mm		
200 x 1000	150	74
200 x 1200		89
250 x 1000		82
250 x 1200		100

Grating only

External casement size in mm	Pieces per pallet	€/pc.
Mesh size 30/30, installation height 30 mm		
200 x 1000	150	51
200 x 1200		64
250 x 1000		58
250 x 1200		72

9 Standard gutter gratings: MW 30/30, 30/10

Suitable for most gutter systems; with casement upon request Delivery time B.

10



11

Please indicate **BB** x **CB** in mm (**BB** = bearing bar, **CB** = cross bar).

12

13

Mesh width in mm	Grating size in mm in mm	Pieces per pallet	€/pc.
Installation height 20 mm			
30/10	122 x 500	100	34
30/10	122 x 750		41
30/10	122 x 1000		51
Installation height 45 mm			
30/10	135 x 500	100	40
30/10	135 x 750		48
30/10	135 x 1000		63
30/30	135 x 500		34
30/30	135 x 750		42
30/30	135 x 1000		51

14

15

16

17

18



Pressure-locked gratings: special sizes

With encasement upon request.

MW 30/30/1.5

Installation height in mm	Price m ² /€
Surface up to 0.5 m ²	
20	139
25	152
30	157
40	163
up to 0.6 m ²	
20	135
25	149
30	156
40	162
up to 0.7 m ²	
25	146
30	147
40	161
up to 0.99 m ²	
25	144
30	146
40	158
from 1,0 m ²	
25	139
30	144
40	157

MW 30/10/1.5

Installation height in mm	Price m ² /€
Surface up to 0.5 m ²	
20	215
25	237
30	248
40	255
up to 0.6 m ²	
20	206
25	233
30	245
40	254
up to 0.7 m ²	
20	198
25	229
30	249
40	243
up to 0.99 m ²	
25	227
30	238
40	239
from 1,0 m ²	
25	221
30	227
40	239

! Minimum priced size:

Grating = 0.4 m²

Casement = 1 mm

! Casement for all installation heights = €14.50.

Calculation example:

grating size 46cm x 107cm = 0.49 m²,

installation height 30 mm, MW 30/10.

€248 x 0.49 m² = €121.52



Maximum grating sizes:

BB up to 1000 mm: 1000 x 2000 mm

BB up to 1500 mm: 1500 x 1800 mm

Larger gratings are produced in several parts.

Surcharge for	Price €
Material thickness:	
2 mm	Surcharge 15%
3 mm (not available for installation heights 20 mm and 25 mm)	30% surcharge
Bearing bar > cross bar	20% surcharge
Welded together	24
Reinforcing bracket 50 x 3 mm	€24 rm
Anti-slip variant	Surcharge 15%



The special patented frame profile convinces with its extraordinary stability.

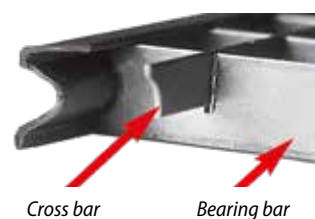

Please note: The smaller grating measure is always the bearing bar measure unless indicated otherwise, e.g. grating size 450 x 890 mm. 450 mm = bearing bar measure.

1
2
3
4
5
6
7
8
9
10
11
12
13
14
15
16
17
18

Cast iron stair steps:

Stair steps, mash size 30 x 30 / 30 x 10. Pressure-fit version, hot-dipped, technical design and hole pattern comply with DIN 24531. Delivery time B.

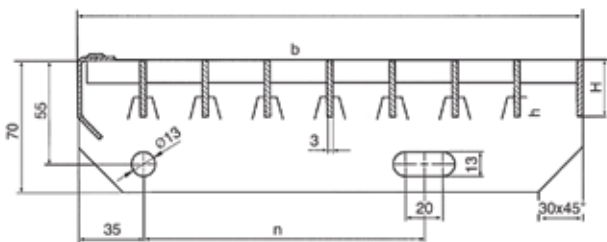

n-measures for step width

160 mm	n = 70 mm
up to 170 mm	n = 90 mm
up to 240 mm	n = 120 mm
up to 294 mm	n = 150 mm
up to 295 mm	n = 180 mm



! Mixed pallets possible

MW 30/30

in mm (height / thickness)	External grating size in mm (W x H)	Pallet/pc.	Price €
30/2	600 x 240	30	54
30/2	600 x 270		58
30/2	800 x 240		69
30/2	800 x 270		74
30/2	1000 x 240		82
30/2	1000 x 270		89
40/3	1200 x 240		98
40/3	1200 x 270		117

! Other sizes upon request.



! Mixed pallets possible

MW 30/10

in mm (height / thickness)	External grating size in mm (W x H)	Pallet/pc.	Price €
30/2	600 x 240	30	75
30/2	600 x 270		81
30/2	800 x 240		92
30/2	800 x 270		104
30/2	1000 x 240		118
30/2	1000 x 270		124
40/3	1200 x 240		135
40/3	1200 x 270		157

Custom-made WOLFA – products

! Other sizes upon request.

Special sizes: 15% surcharge

Example price calculation for special sizes:

e.g. size 730 x 240 mm, installation height 30/2 MW 30/10
Same price as next standard size 800 x 240 = € 92 + 15% surcharge.



Composters / screen sieves

For garden and building site, screen surface made of expanded metal with solid angular frame, completely hot-dipped, mesh size approx. 40 x 15 mm



Screen sieve with adjustable backing

Screen sieve

Screen sieve with adjustable backing.

Size in cm	Price €
60 x 100	43
60 x 120	48
80 x 100	48
80 x 120	52



Screen sieve with wheelbarrow fixture

Screen sieve

With wheelbarrow fixture. Fits most wheelbarrows
From 85 liter hold capacity.

Size in cm	Price €
60 x 100	50



Metal composter

Metal composters

4 parts that interlock. Robust, hot-dipped expanded metal design.

Size in cm	Price €
80 x 80 x 70	106
100 x 100 x 80	138



Bottom or lid for metal composters

Bottom or lid for metal composters

2-Part component.

Size in cm	Price €
80 x 80 x 70	52
100 x 100 x 80	58



Drainage gutters

The WOLFA drainage gutters of glass fiber reinforced polyester with their high amount of glass fibers are the basis to the successful gutter system. It is permanently resistant to weather and heat-proof up to 200°C, short-term even up to 250°C; the material is inherently stable and can be used under hot asphalt. It contains no plasticizers and is UV-proof. Another major advantage is its resistance to petrol, liquid manure and many chemicals. The wide range of gutter types and grating variants allow applications up to load class E 600.

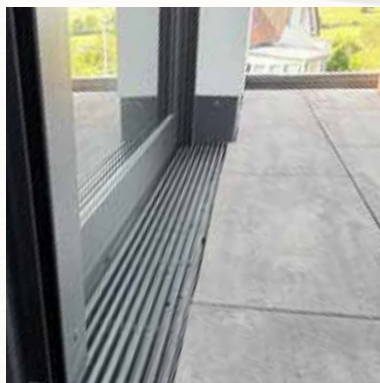



Drainage systems / linear drainage

70-101

AquaStop

72-79

Ultra / Ultra 150 / AquaStop 150-OS / Premium

73

Klassik / Mini / Maxi

74

Accessories

75-79

WOLFA gutter types with cover - overview

80

Technical Data

81

100/6 and 100/8,5S

82

100/6V and 100/8V

84

100V line

84

100/10T

88

150F, 150K and 150V line

90-91

200F and 200V line

92-93

Slot drains

94-97

100/6VS, 100/8VS and 100VS line

95

Drainage gutters

98-102

100/6VD

99

AquaStop Ultra 150 / AquaStop Drain 150

100

Fixo 150

100

Fixo 110

101

Point drainage / yard catch basin

102-103

1

2

3

4

5

6

7

8

9

10

11

12

13

14

15

16

17

18



Drainage gutter AquaStop

The multi-channel gutter, not only good looking but also extremely robust. The many variants and extensive range of accessories make them ideal for draining parking decks and underground parking.

- robust and extremely break-resistant
- resistant to de-icing salt and frost
- corrosion-resistant
- installation height of 25, 30 or 38 mm
- easy to clean
- rattle-free



AquaStop in concrete



AquaStop in pavement



AquaStop in asphalt



Flat gutters: AquaStop Ultra / Ultra 150 / 150-OS / Premium

see our
discounts



Color(s):



charcoal grey

AquaStop Ultra- load class D 400

Multi-channel gutter without grating for the drainage of residual or melt water in underground parking and parking decks. Installation height only 25 mm! With drain connection NW 50, NW 70, NW 100 or NW 125. Charcoal grey, car and truck trafficable. Easy overlap plug connection.



Gutter length in mm	Pieces per pallet	Item number	Price €
1,000	60	102010030	69.50

Installation height 25 mm; width 120 mm; inner width 14 mm
Water intake volume: 1.10 l/m

AquaStop Ultra 150 - load class E 600

Multi-channel gutter without grating for the drainage of residual or melt water in underground parking and parking decks or for garages and patios / installation height of only 25 mm! With drain connection NW 50, NW 70, NW 100 or NW 125. Charcoal grey, car and truck trafficable. Easy overlap plug connection.



Gutter length in mm	Pieces per pallet	Item number	Price €
1,000	60	102010040	78.50

Installation height 25 mm; width 150 mm; inner width 10 mm
Water intake volume: 1.20 l/m

AquaStop 150-OS with sealing flange

Multi-channel gutter without grating for the drainage of residual or melt water in underground parking and parking decks.

Installation height only 25 mm! The slot width is 10 mm. With drain connection NW 50, NW 70, NW 100 or NW 125. Charcoal grey, car and truck trafficable. Easy overlap plug connection.

NEW



for OS coating

Gutter length in mm	Pieces per pallet	Item number	Price €
1,000	60	102010045	80

Installation height 25 mm; width 150 mm; inner width 10 mm
Water intake volume: 0.90 l/m

AquaStop Premium - load class E 600

Multi-channel gutter without grating for the drainage of residual or melt water in underground parking and parking decks.

Installation height only 30 mm! The slot width is 10 mm. With drain connection NW 50, NW 70, NW 100 or NW 125. Charcoal grey, car and truck trafficable. Easy overlap plug connection.



Gutter length in mm	Pieces per pallet	Item number	Price €
1,000	60	102010060	78.50

Installation height 30 mm; width 120 mm; inner width 10 mm
Water intake volume: 1.20 l/m

Flat gutters: AquaStop Klassik / AquaStop Mini / AquaStop Maxi

AquaStop Klassik - load class D 400

Multi-channel gutter without grating for the drainage of residual or melt water in underground parking and parking decks.

Installation height of 38 mm! The slot width is 14 mm. With optional drain connection NW 50, NW 70, NW 100 or NW 125. Charcoal grey, car and truck trafficable. Easy plug-in connection by means of a safety seal seam.

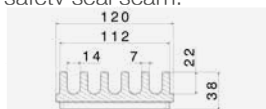

Gutter length in mm	Pieces per pallet	Item number	Price €
1,000	60	102010020	69

Installation height 38 mm; width 120 mm; inner width 14 mm
Water intake volume: 1.40 l/m

AquaStop Mini - car-trafficable

The small multi-channel gutter, perfectly suited for garages, patios etc.

Installation height only 38 mm! With drainage connection option NW 70. Charcoal grey, car trafficable. Easy overlap plug connection.

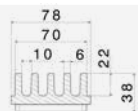

Gutter length in mm	Pieces per pallet	Item number	Price €
1,000	60	102010010	58

Installation height 38 mm; width 78 mm; inner width 10 mm
Water intake volume: 0.80 l/m

AquaStop Maxi - load class E 600

Multi-channel gutter without grating for the drainage of residual or melt water in underground parking and parking decks. Installation height only 38 mm! With drain connection NW 50, NW 70, NW 100 or NW 125. Charcoal grey, car and truck trafficable. Easy overlap plug connection.

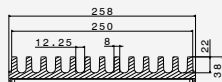
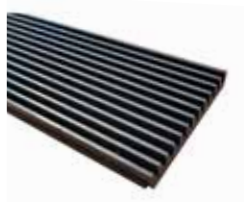

Gutter length in mm	Pieces per pallet	Item number	Price €
1,000	60	102010070	135

Installation height 38 mm; width 258 mm; inner width 12 mm
Water intake volume: 3.18 l/m



Installation AquaStop with gutter elevation



Installation AquaStop in recess



AquaStop Maxi

Accessories: AquaStop-Ultra

Picture	Description	Item number	Price €
	Metal strip mounted for AquaStop Ultra (2 pieces per gutter, 1000 mm long)	102051010	7.50 per pair
	installation cover plate for AquaStop Ultra for drainage gutters 1000 x 120 mm	102053020	11.50
	for variable elbow 128 x 128 mm	102054630	7.50
	for inlet piece straight 160 x 120 mm	102054130	7.50
	Plastic elevation for AquaStop Ultra for height fixation between 30-300 mm or 30-500 mm Required gutter accessories 1 x elevation, 2 x nuts, 1 x mounting bracket for width 120 mm, 2 x protection plus 1 piece at each end and 1 pieces per intake or variable elbow	102052020	47 (30- 300 mm)
		102052120	53 (30- 500 mm)
	Straight intake piece for AquaStop Ultra size 160 x 120 mm with removable inspection flap, without drain connection ring !	102054030	100
	Variable intake / elbow piece for AquaStop Ultra size 128 x 128 mm with removable inspection flap, without drain connection ring !	102054530	118.50
	Variable elbow piece for AquaStop Ultra Size 128 x 128 mm, incl. two lateral gutter end covers and connec- tion possibility on four sides!	102054830	80
	Variable curve for AquaStop Ultra up to 7°. size 100 x 120 mm	102054730	49.50
	Lateral gutter end guard for AquaStop Ultra (per piece)	102055030	5.50
	Drain connection ring NW 125 for AquaStop Ultra	102056995	8.50
	Drain connection ring NW 100 for AquaStop Ultra	102056595	9
	Drain connection ring NW 70 for AquaStop Ultra	102056395	10
	Drain connection ring NW 100 for AquaStop Ultra with odor stop	102056795	34.50
	Drain connection ring NW 50 with lateral outlet	102056195	20.50
	Cleaning rake (without handle)	102059020	65.50

AquaStop – manyways to use!











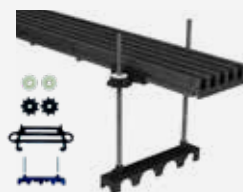

Underground parking
Parking decks
Fire department gateways
Cheese dairies
Pedestrian paths
Patios



Accessories: AquaStop Ultra 150 / AquaStop Drain 150 / AquaStop 150-OS

Picture	Description	Item number	Item number	Price €
		AquaStop Ultra 150/ AquaStop Drain 150	AquaStop 150-OS	
	Assembled sheet metal strip (2 pieces per gutter, 1000 mm long)	102051040		11 per pair
	Installation cover plate			
	Drainage gutter 150-Ultra/Drain, 1000 x 150 mm	102053040		15
	Drainage gutter 150-OS, 1000 x 150 mm		102053020	11.50
	Variable elbow piece 158 x 158 mm	102054640	–	10
	Intake piece straight 160 x 150 mm	102054140	102054130	10
	Plastic elevation for height fixation between 30-300 mm or 30-500 mm Required gutter accessories 1 x elevation, 2 x nuts, 1 x mounting bracket for width 150 mm, 2 x protection plus 1 piece at each end and 1 pieces per intake or variable elbow	102052040		52 (30- 300 mm)
		102052140		58 (30- 500 mm)
	Variable elbow piece size 158 x 158 mm with two lateral gutter end guards and connection possibility on four sides;!	102054540	–	93
	Straight intake filter size 160 x 150 mm with detachable inspection flap; without drain connection ring.	102054040	102054045	104
	Lateral gutter end guard	102055040	102055045	5.50 (per piece)
	Drain connection ring NW 125	102056995		8.50
	Drain connection ring NW 100	102056595		9
	Drain connection ring NW 70	102056395		10
	Drain connection ring NW 100 with odor stop	102056795		34.50
	Drain connection ring NW 50 with lateral outlet	102056195		20.50
	Cleaning rake (without handle)	102059040		70.50







Accessories: AquaStop Premium

Picture	Description	Item number	Price €
	Metal strip mounted for AquaStop Premium (2 pieces per gutter, 1000 mm long)	102051010	7.50 per pair
	Installation cover plate for AquaStop Premium for drainage gutters 1000 x 120 mm	102053020	11.50
	for variable elbow 120 x 120 mm	102054630	7.50
	for inlet piece straight 136 x 120 mm	102054120	7.50
	Plastic elevation for AquaStop Premium for height fixation between 30-300 mm or 30-500 mm Required gutter accessories 1 x elevation, 2 x nuts, 1 x mounting bracket for width 120 mm, 2 x protection plus 1 piece at each end and 1 pieces per intake or variable elbow	102052020	47 (30- 300 mm)
		102052120	53 (30- 500 mm)
	Variable elbow piece for AquaStop Premium size 128 x 128 mm with two lateral gutter end guards and connection possibility on four sides;!	102054560	80
	Straight intake piece for AquaStop Premium size 136 x 120 mm with detachable inspection flap; without drain connection ring.	102054060	99
	Lateral gutter end guard for AquaStop (per piece)	102055060	5.50
	Drain connection ring NW 125 for AquaStop Premium	102056995	8.50
	Drain connection ring NW 100 for AquaStop Premium	102056595	9
	Drain connection ring NW 70 for AquaStop Premium	102056395	10
	Drain connection ring NW 100 for AquaStop Premium with odor stop	102056795	34.50
	Drain connection ring NW 50 with lateral outlet	102056195	20.50
	Cleaning rake (without handle)	102059020	65.50











Accessories: AquaStop Klassik

Picture	Description	Item number	Price €
	Metal strip mounted for AquaStop Klassik (2 pieces per gutter, 1000 mm long)	102051010	7.50 per pair
	Installation cover plate for AquaStop Klassik for drainage gutters 1000 x 120 mm	102053020	11.50
	for variable elbow 120 x 120 mm	102054620	7.50
	for inlet piece straight 136 x 120 mm	102054120	7.50
	Plastic elevation for AquaStop Klassik for height fixation between 30-300 mm or 30-500 mm Required gutter accessories 1 x elevation, 2 x nuts, 1 x mounting bracket for width 120 mm, 2 x protection plus 1 piece at each end and 1 pieces per intake or variable elbow	102052020	47 (30- 300 mm)
		102052120	53 (30- 500 mm)
	Variable elbow piece for AquaStop Klassik size 120 x 120 mm with two lateral gutter end guards and connection possibility on four sides;!	102054520	80
	Straight intake piece for AquaStop Klassik size 136 x 120 mm with detachable inspection flap; without drain connection ring.	102054020	84.50
	Lateral gutter end guard for AquaStop Klassik (per piece)	102055020	5.50
	Drain connection ring NW 125 for AquaStop Klassik	102056995	8.50
	Drain connection ring NW 100 for AquaStop Klassik	102056595	9
	Drain connection ring NW 70 for AquaStop Klassik	102056395	10
	Drain connection ring NW 100 for AquaStop Klassik with odor stop	102056795	34.50
	Drain connection ring NW 50 with lateral outlet	102056195	20.50
	Cleaning rake (without handle)	102059020	65.50

Accessories: AquaStop Mini













Picture	Description	Item number	Price €
	Metal strip mounted for AquaStop Mini (2 pieces per gutter, 1000 mm long)	102051010	7.50 per pair
	Installation cover plate for AquaStop Mini for drainage gutters 1000 x 78 mm	102053010	11.50
	for inlet piece 135 x 78 mm	102054110	7.50
	Metal elevation for AquaStop Mini for height fixation between 30 mm and 300 mm Requirements: 2 pieces per gutter meter , only together with metal strips. Other heights upon request.!	102052410	57 per pair
	Straight intake filter for AquaStop Mini size 135 x 78 mm with detachable inspection flap; for drain connection ring NW 70	102054010	84.50
	Lateral gutter end guard for AquaStop Mini (per piece)	102055010	5
	Drain connection ring NW 70 for AquaStop Mini	102056010	7.50
	Cleaning rake (without handle)	102059010	70.50

Accessories: AquaStop Maxi



Picture	Description	Item number	Price €
	Metal strip mounted for AquaStop Maxi (2 pieces per gutter, 1000 mm long)	102051070	14.50
	Installation cover plate for AquaStop Maxi for drainage gutters 1000 x 258 mm	102053070	21.50
	for straight intake filter	102054170	15.50
	For variable elbow piece	102054670	15.50
	Metal elevation for AquaStop Maxi for height fixation between 30 mm and 300 mm Requirements: 2 pieces per gutter meter , only together with metal strips. Other heights upon request.!	102052470	68 per pair
	Variable elbow piece, size: 258mm x 258mm, incl. 2 gutter end guards.	102054570	104
	Straight intake piece for AquaStop Maxi, with removable inspection flap without drain connection ring !	102054070	130
	Lateral gutter end guard for AquaStop Maxi (per piece)	102055070	8
	Drain connection ring NW 125 for AquaStop Maxi	102056995	8.50
	Drain connection ring NW 100 for AquaStop Maxi	102056595	9
	Drain connection ring NW 70 for AquaStop Maxi	102056395	10
	Drain connection ring NW 100 for AquaStop Maxi with odor stop	102056795	34.50
	Drain connection ring NW 50 with lateral outlet	102056195	20.50

WOLFA gutter types with cover at a glance

The WOLFA gutters are available in many variants. Depending on their applications in the private / public building industry or in landscaping, we supply

 <p>Drainage gutter 100/6</p> <p>Cross section in cm² 22.0 Liters / meter 2.2</p>	 <p>Drainage gutter 100/8.5S</p> <p>Cross section in cm² 55.5 Liters / meter 5.6</p>	 <p>Drainage gutter 100/10T</p> <p>Cross section in cm² 95.3 Liters / meter 9.5</p>
 <p>Drainage gutter 100/6V</p> <p>Cross section in cm² 27.0 Liters / meter 2.7</p>	 <p>Drainage gutter 100/8V</p> <p>Cross section in cm² 55.8 Liters / meter 5.6</p>	 <p>Drainage gutter 100V line</p> <p>Cross section in cm² 90.4 Liters / meter 9.0</p>
 <p>Drainage gutter 150V line</p> <p>Cross section in cm² 257.6 Liters / meter 25.8</p>	 <p>Drainage gutter 150K</p> <p>Cross section in cm² 176.8 Liters / meter 17.6</p>	 <p>Drainage gutter 150F</p> <p>Cross section in cm² 91.5 Liters / meter 9.2</p>
 <p>Drainage gutter 200V line</p> <p>Cross section in cm² 332.9 Liters / meter 33.3</p>	 <p>Drainage gutter 200F</p> <p>Cross section in cm² 119.1 Liters / meter 11.9</p>	<p>Color(s):</p> <ul style="list-style-type: none">  light grey  charcoal grey (+ 10%)

WOLFA drainage gutters with slotted top made of GRP

 <p>WOLFA slot drain 100/6VS</p> <p>Cross section in cm² 22.0 Liters / meter 2.2</p>	 <p>WOLFA slot drain 100/8VS</p> <p>Cross section in cm² 55.8 Liters / meter 5.6</p>	 <p>WOLFA slot drain 100VS line</p> <p>Cross section in cm² 90.4 Liters / meter 9.0</p>
---	--	--

Linear drainage / technical data



Technical overview: WOLFA GRP drainage gutters with cover

Types	100/6	100/8,5 S	100/6V	100/8V	100/10T	100V line	150F With 8-mm GRP edge	150K With 8-mm GRP edge	150V line With 8-mm GRP edge	200F With 8-mm GRP edge	200V line With 8-mm GRP edge
Length	100 cm / 50 cm	100 cm / 50 cm	100 cm / 50 cm	100 cm / 50 cm	100 cm / 50 cm	100 cm / 50 cm	100 cm / 50 cm	100 cm / 50 cm	100 cm / 50 cm	100 cm / 50 cm	100 cm / 50 cm
Installation width	11.3 cm	11.3 cm	13.5 cm	13.5 cm	13.5 cm	13.5 cm	22.8 cm	22.8 cm	22.8 cm	27.4 cm	27.4 cm
Height	5.8 cm	10 cm	5.8 cm	10 cm	13.3 cm	14.9 cm	9.8 cm	15 cm	23.8 cm	9.8 cm	23.8 cm
Inner width	8.5 cm	8.5 cm	9.5 cm	9.5 cm	9.8 cm	9.5 cm	16.4 cm	16.4 cm	16.4	21 cm	21.0 cm
Weight	1.4 kg 0.7 kg	1.75 kg 0.9 kg	1.5 kg 0.8 kg	2.3 kg 1.2 kg	2.6 kg	2.4 kg 1.2 kg	3.9 kg 1.9 kg	3.9 kg 1.9 kg	5.8 kg 2.9 kg	4.4 kg 2.2 kg	6.0 kg 3.0 kg
Color	light grey	light grey	light grey + charcoal	light grey + charcoal	light grey	light grey + charcoal	light grey	light grey	light grey	light grey	light grey
Nominal width / drain spout	NW 100	NW 100	NW 100	NW 100	NW 100	NW 100	NW 125	NW 125	NW 125	NW 125	NW 125
Load capacity	A 15	A 15	A 15 - C 250	A 15 - C 250	A 15	A 15 - D 400	A 15 - D 400	A 15 - D 400	A 15 - D 400	B 125 - D 400	B 125 - D 400
Grating	Click-on grating	Click-on grating	screwed in place	screwed in place	screwed in place	screwed in place	screwed in place	screwed in place	screwed in place	screwed in place	screwed in place
Cross section in cm ²	22.0	55.5	27.0	55.8	95.3	90.4	91.5	176.8	257.6	119.1	332.9
Liter/meter	2.2	5.6	2.7	5.60	9.5	9.0	9.2	17.6	25.8	11.9	33.3

Accessories: WOLFA GRP drainage gutters

Types	100/6	100/8,5 S	100/6V	100/8V	100/10T	100V line	150F	150K	150V line	200F	200V line
Sheet metal strips	■	■	■	■			■				
gutter end guard	■	■	■	■	■	■	■	■	■	■	■
Drain connection, complete	NW 100	NW 100	NW 100	NW 100	NW 100	NW 100	NW 125	NW 125	NW 125	NW 125	NW 125
Adapter for catch basin			■	■			■			■	
Lateral drain connection					NW 100	NW 100		NW 125	NW 125	NW 125	NW 150
Variable elbow piece	■		■	■		■					
Catch basin			■	■	■	■	■	■	■	■	■
90-degree corner angle		■									
Gutter elevation	■	■	■	■			■	■			

Drainage gutters: 100/6 and 100/8,5S load class A15

The perfect flat gutter for patio or garage drainage in private homes.
Available with clamp-type slotted grating or pressure-locked grating. Easy overlap connection.



Color(s):



light grey

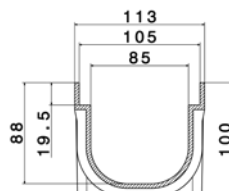
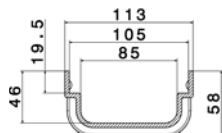

Drainage gutter 100/6

Installation height 58 mm
Width 113 mm, inner width 85 mm
Drain spout NW 100

Drainage gutter 100/8.5S

Installation height 100 mm
Width 113 mm, inner width 85 mm
Drain spout NW 100

Gutter body

Gutter body without grating	Gutter length in mm	Pieces per pallet	Item number	Price €
100/6 without grating	1,000	56	103010101	23
	500		103010201	15
100/8,5S without grating	1,000		103020101	24
	500		103020201	16

Please note:
All gutters come with grating



Slotted grating
A 15



Pressure-locked grating
MW 30/30
A 15







Pressure-locked grating
MW 30/10
A 15

Gutter covers

Class	Gratings	Gutter length in mm	Pieces per pallet	Item number	Price €
A 15	Slotted grating	1,000	56	103050110	17
		500		103050120	11
	Pressure-locked grating MW 30/30	1,000		103050210	20.50
		500		103050220	14.50
	Pressure-locked grating MW 30/10	1,000		103050310	29
		500		103050320	19

Accessories: 100/6

Picture	Description	Item number	Price €
	Metal strips mounted for 100/6 (2 pieces, each 1000 mm long)	104281100	7.50 per pair
	Gutter end guard for 100/6 (per piece)	103071301	8
	Drain connection NW100 for 100/6, complete with intake filter, odor stop and two lateral end guards.	103071001	22.50
	Variable elbow piece 100/6 for corner joint, T-joint or cross connection, two lateral end guards (length 305 mm)		
	Elbow piece without grating, light grey	103071501	48,50
	Slotted grating class A 15	103074010	11
	Pressure-locked grating MW 30/30 class A 15	103074011	14.50
	Pressure-locked grating MW 30/10 class A 15	103074012	19.50
	Metal elevation for 100/6 for height fixation between 30 mm and 300 mm (2 pieces, each 1000 mm long) only together with sheet metal strips. Other heights upon request.!	104281000	57 per pair

Accessories: 100/8.5S

Picture	Description	Item number	Price €
	Metal strips mounted for 100/8.5S (2 pieces, each 1000 mm long)	104281100	7.50 per pair
	Gutter end guard for 100/8.5S (per piece)	103081301	8
	Drain connection 100/8.5S with discharge nozzle NW 100, mud bucket and two gutter end guards	103081001	23
	90-degree corner angle size 470 x 365 mm for 100/8.5S		
	90-degree corner angle without grating, light grey	103082001	48.50
	Slotted grating class A 15	103082010	11
	Pressure-locked grating MW 30/30 class A 15	103082011	17
	Pressure-locked grating MW 30/10 class A 15	103082012	19.50

Product information:

Drainage gutters: 100/6V, 100/8V and 100V line class A 15-D 400

The WOLFA gutters with installation heights from 58 to 149 mm are suited for many applications. With water level decline and internally screwed-in-place grating. Easy overlap plug connection. One catch basin for all three sizes. All gratings are screwed. All drain spouts NW 100.

Color(s):

- light grey
- charcoal grey (+ 10%)



Gutter 100/6V - up to class C250

Installation height 58 mm
Width 135 mm, inner width 95 mm
Drain spout NW 100

Gutter 100/8V - up to class C250

Installation height 100 mm
Width 135 mm, inner width 95 mm
Drain spout NW 100

Gutter 100V line - up to class D400

Installation height 149 mm
Width 135 mm, inner width 95 mm
Drain spout NW 100

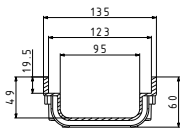

Gutter 100/6V

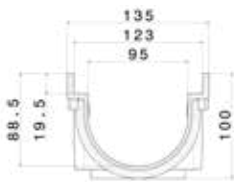

Gutter 100/8V

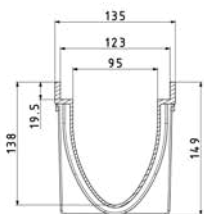

Gutter 100V-Line

Gutter body without grating	Gutter length in mm	Pieces per pallet	Item number light grey	Price € light grey	Item number charcoal grey	Price € charcoal grey
100/6V without grating	1,000	56	104010101	24	104010102	26.40
	500		104010201	16	104010202	17.60
100/8V without grating	1,000		104030101	25	104030102	27.50
	500		104030201	16.50	104030202	18.15
100V line without grating	1,000		104040101	26	104040102	28.60
	500		104040201	18	104040202	19.80

Gutter covers (see overview on page 89)

Class	Gratings	Gutter length in mm	Pieces per pallet	Item number	Price €
A 15	Slotted grating	1,000	56	104050101	18
		500		104050102	10.50
	Pressure-locked grating MW 30/30	1,000		104050111	25.50
		500		104050112	18
	Pressure-locked grating MW 30/10	1,000		104050121	35
		500		104050122	25.50
	Longitudinal GRP bar grating, light color	1,000		104050151	47
		500		104050152	26.50
	Longitudinal GRP bar grating, charcoal grey	1,000		104050161	51.70
		500		104050162	29.15
	Slotted GRP design grating, light color	1,000		104050131	39
		500		104050132	25
	Slotted GRP design grating, charcoal grey	1,000		104050141	42.90
		500		104050142	27.50
	V2A slotted grating	1,000		104050171	60.50
		-		-	-
V2A perforated design grating	1,000	104050181	42.50		
	-	-	-		
Longitudinal V2A bar grating	1,000	104050191	198		
	-	-	-		
B 125	Plastic grating	-	-	-	
	500	104050302	15		
Pressure-locked V2A grating 30/10	1,000	104050341	265		
	-	-	-		
C 250	Pressure-locked grating MW 30/30	1,000	104050501	36	
	500	104050502	26.50		
	Pressure-locked grating MW 30/10	1,000	104050511	57	
		500	104050512	30	
	V2A slotted grating	1,000	104050551	183	
		500	104050552	-	
	V2A perforated design grating	1,000	104050561	183	
		-	-	-	
Cast iron grating	-	-	-		
500	104050602	50			
D 400	Cast iron grating	-	-	-	
	500	104050702	54		
Wood insert	1,000	104050951	14		

Please note:
All gutters come with grating

Product information: **A dazzling array of gratings type 100/6V, 100/8V and 100V-line**

Thanks to the large variety of grating variants for load class A 15 – D 400, these gutters are suitable for all areas around the house, for commercial as well as public places. All gratings are screwed. Easy overlap plug connection.



Longitudinal GRP bar grating, charcoal grey | A 15



Longitudinal GRP bar grating, light grey | A 15



Plastic grating charcoal grey B 125

NEW



Slotted GRP design grating, charcoal grey | A 15



Longitudinal GRP bar grating, light grey | A 15



Slotted grating V2A slotted grating A 15 and C 250



Pressure-locked grating MW 30/30 | A 15 and C 250



Pressure-locked grating MW 30/10 A 15 and C 250



Pressure-locked grating V2A MW 30/10 | C 250



V2A perforated design grating A 15 and C 250



Longitudinal V2A bar grating A 15



Cast iron grating C 250 and D 400

Accessories: 100/6V

! Color charcoal grey + 10% surcharge

Picture	Description	Item number light grey	Item number charcoal grey	Price € Color light grey
	Sheet metal strip installed for 100/ 6V (2 pieces, each 1000 mm long)	104281100		7.50
	Gutter end guard for 100/6V (per piece)	104061301	104061302	8
	Drain connection NW100 for 100/6V, complete with intake filter, odor stop and two lateral end guards	104061001	104061002	22.50
	Drain connection ring 100 NW 50 with lateral outlet	104281200	104281300	20.50
	Adapter 100/6V for catch basin	104063001	104063002	8
	Variable elbow piece for 100/6V with two gutter end guards without grating, light grey	104061501	104061502	51
	Grating covers for variable elbow piece see page 87 (as for 100V line)	see page 87.		
	Catch basin for 100/6V see gap 87 (as for 100V line)	see page 87.		
	Elevation for 100/6V for installations at heights between 30 and 300 mm (2 pieces, each 1000 mm long) only together with sheet metal strips. Other heights upon request.!	104281000		57 per pair

Accessories: 100/8V

! Color charcoal grey + 10% surcharge

Picture	Description	Item number light grey	Item number charcoal grey	Price €
	Sheet metal strip installed for 100/8V (2 pieces per, 1000 mm long)	104281100		7.50 per pair
	Gutter end guard for 100/8V (per piece)	104071301	104071302	8
	Drain connection NW100 for 100/8V, complete with removable intake filter, odor stop and two lateral end guards	104071001	104071002	23
	Drain connection ring 100 NW 50 with lateral outlet	104281200	104281300	20.50
	Adapter 100/8V for catch basin	104073001	104073002	8
	Variable elbow piece for 100/8V with two gutter end guards without grating, light grey	104071501	104071502	53
	Grating covers for variable elbow piece see gap 87 (as for 100V line)	see page 87.		
	Catch basin for 100/8V see gap 87 (as for 100V line)	see page 87.		
	Elevation for 100/6V for installations at heights between 30 and 300 mm (2 pieces, each 1000 mm long) only together with sheet metal strips. Other heights upon request.!	104281000		57

Drainage systems / accessories

Accessories: 100V line

! Color charcoal grey + 10% surcharge

Picture	Description	Item number light grey	Item number charcoal grey	Price € Color light grey
	Gutter end guard for 100V line (per piece)	104081301	104081302	8
	Drain connection for 100V line with discharge nozzle NW 100 mud bucket with leaf screen and two gutter end guards 100V line	104081001	104081002	23
	Lateral drain connection NW 100 for 100V line	104081101	104081102	9
	Drain connection ring 100 NW 50 with lateral outlet	104281200	104281300	20.50
	Variable elbow piece 100V-Line for corner joint, T-joint or cross connection, 2 gutter end guards without grating, light grey, length 305 mm	104081501	104081502	53
	Grating covers for variable elbow piece			
	Slotted grating class A 15	104084010		12
	Pressure-locked grating MW 30/30 class A 15	104084011		16
	Pressure-locked grating MW 30/10 class A 15	104084012		21
	Slotted GRP design grating class A 15	104084013	104084014	24
	Longitudinal GRP bar grating class A 15	104084015	104084016	31
	Slotted V2A grating class A 15	104084017		upon request!
	Slotted V2A design grating class A 15	104084018		upon request!
	Longitudinal V2A bar grating class A 15	104084019		143
	Plastic grating class B 125	-	104084030	14.50
	Pressure-locked V2A grating MW 30/10 class B	104084034		upon request!
	Pressure-locked grating MW 30/30 class C 250	104084050		25.50
	Pressure-locked grating MW 30/10 class C 250	104084051		30
	Slotted V2A grating class C 250	104084055		upon request!
	cast iron grating class C 250	104084060		34.50
	Cast iron grating class D 400	104084070		43
	Wood insert	104084095		11
	Catch basin for 100V-Line with gutter connection on one or two sides, galvanized mud trap, with 1 gutter end guard 100V line and drain connection ring NW 100 and odor stop without grating, light grey, size 305 x 300 mm (LxH)	104084001	104084002	92
	Grating covers for catch basin			
	Slotted grating class A 15	104084010		12
	Pressure-locked grating MW 30/30 class A 15	104084011		16
	Pressure-locked grating MW 30/10 class A 15	104084012		21
	Slotted GRP design grating class A 15	104084013	104084014	24
	Longitudinal GRP bar grating class A 15	104084015	104084016	31
	Slotted V2A grating class A 15	104084017		upon request!
	Slotted V2A design grating class A 15	104084018		upon request!
	Longitudinal V2A bar grating class A 15	104084019		143
	Plastic grating class B 125	104084030		14.50
	Pressure-locked V2A grating MW 30/10 class B	104084034		upon request!
	Pressure-locked grating MW 30/30 class C 250	104084050		25.50
	Pressure-locked grating MW 30/10 class C 250	104084051		30
	Slotted V2A grating class C 250	104084055		upon request!
	cast iron grating class C 250	104084060		34.50
	Cast iron grating class D 400	104084070		43
	Wood insert	104084095		11

Product information:

Drainage gutters: 100/10T, load class A 15

The gutter for many applications with surface-mounted, screwed-in-place slotted grating or longitudinal V2A bar grating. The entire gutter body is covered by the grating, i.e. the gutter edges are completely protected.



Unmatched protection!
The grating completely covers the gutter body
(Illustration with longitudinal V2A bar grating)

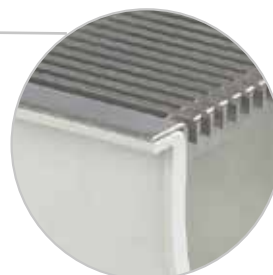

Color(s):



light grey

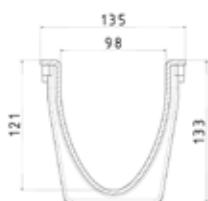

Drainage gutter 100/10T

Installation height 133 mm
Width 135 mm, inner width 98 mm
Length 1000 mm
Drain spout NW 100

Gutter body without grating	Gutter length in mm	Pieces per pallet	Item number	Price €
100/10T without grating	1,000	56	104810101	26.50
	500		104810201	17

Please note:
All gutters come with grating



Slotted grating A 15



Longitudinal V2A bar grating A 15

Gutter covers

Class	Gratings	Gutter length in mm	Pieces per pallet	Item number	Price €
A 15	Slotted grating	1,000	56	104850101	19.50
		500		104850102	11
	Longitudinal V2A bar grating	1,000		104850191	196
		500		-	-

Accessories: 100/10T

Picture	Description	Item number	Price €
	Drain connection 100/10T with discharge nozzle NW 100, Mud bucket with leaf screen and two gutter end guards	104881001	23
	Gutter end guard for 100/10T (per piece)	104881301	8
	Lateral drain connection NW 100 for 100/10T	104881101	9
	Catch basin for 100/10T, complete with gutter connection for one/two sides, mud trap, size 300 x 350 mm (L x H) with 1 gutter end guard 100/10T with drain connection ring NW 100 and odor stop without grating!		
	without grating, light grey	104884001	92
	Slotted grating class A 15	104884010	12
	Longitudinal V2A bar grating class A15	104884019	142



GRP
stable and durable



WOLFA gutter bodies are made of glass fiber reinforced polyester and compression-molded (SMC). The thermosetting plastic material is weather-proof and inherently stable. The material does not become brittle, It resists ultraviolet radiation, is extremely resilient and resistant to a large number of chemicals.

GRP - the superior material

resistant to de-icing salt

frost-proof

heat-proof

easy handling

easy to clean



extremely high load capacity

UV-resistant

resistant to chemicals

Product information:

Drainage gutters: 150F, 150K and 150V line, load class A 15-D 400

These WOLFA gutters with a nominal width of 164 mm are available with an installation height of 238 mm or as flat gutter with an installation height of only 98 mm! All gratings with fourfold security. Easy overlap plug connection. With extra sturdy **8-mm thick GRP edges** or integrated galvanized 4-mm steel edge (upon request).

Color(s):



Color charcoal grey upon request!



Flat gutter 150F

Installation height 98 mm
Width 228 mm, inner width 164 mm
Length 1000 mm
Drain spout NW 125



Drainage gutter 150K

Installation height 150 mm
Width 228 mm, inner width 164 mm
Length 1000 mm
Drain spout NW 125



Drainage gutter 150V line

Installation height 238 mm
Width 228 mm, inner width 164 mm
Length 1000 mm
Drain spout NW 125

Gutter body

Gutter body without grating	Gutter length in mm	Pieces per pallet	Item number light grey	Price €
150F without grating	1,000	60	106010101	74
	500		106010201	40.50
150K without grating	1,000	40	106020101	83
	500		106020201	45
150V line without grating	1,000	30	106030101	88
	500		106030201	48

Please note:
All gutters come with grating

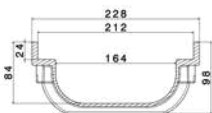

Flat gutter 150F

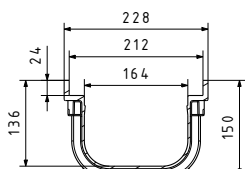

Gutter 150K

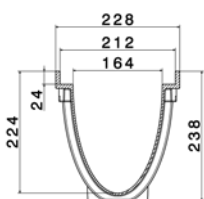

Gutter 150V-Line

Gutter covers



Pressure-locked grating MW 30/30
A 15 and B 125



Pressure-locked grating MW 30/10
A 15 and B 125



Cast iron grating C 250 and D 400

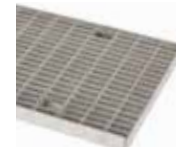

Pressure-locked V2A grating MW 30/10



Longitudinal GRP grating light grey
Class B 125:







Class	Grating variants	Gutter length in mm	Pieces per pallet	Item number	Price €
A 15	Pressure-locked grating MW 30/30	1,000	30	106050111	76
		500		106050112	49.50
	Pressure-locked grating MW 30/10	1,000		106050121	84.50
		500		106050122	56
B 125	Pressure-locked grating MW 30/30	1,000		106050251	103
		500		106050252	68
	Pressure-locked grating MW 30/10	1,000		106050261	115
		500		106050262	75
B 125	Pressure-locked V2A grating MW 30/10	1,000		-	-
		500		106050342	upon request!
B 125	Longitudinal GRP bar grating, light grey	-		-	-
		500		106050152	93
B 125	Longitudinal GRP bar grating, charcoal grey	-	-	-	
		500	106050162	102.50	
C 250	Cast iron grating	-	-	-	
		500	106050602	75	
D 400	Cast iron grating	-	-	-	
		500	106050702	84.50	
Wood insert	Wood insert	1,000	106050951	18.50	
		500	106050952	12	

! All gratings are screwed-in-place.

Drainage systems / accessories



Accessories: 150F

! Charcoal grey upon request

Picture	Description	Item number / light grey	Price € Color light grey
	Metal strips mounted for 150F (2 pieces, each 1000 mm long)	106281100	10 per pair
	Gutter end guard for 150F (per piece)	106061301	10.50
	Drain connection 150F with discharge nozzle NW 125, mud bucket, odor stop and two gutter end guards	106061001	27
	Drain connection ring 125 NW 50 with lateral outlet	102056195	20.50
	Adapter for 150F catch basin	106063001	10.50
	Catch basin for 150F see 150V line	See 150V line below	
	Metal elevation for 150F for height fixation between 30 mm and 300 mm (2 pieces, each 1000 mm long) only together with metal strips Other heights upon request!	106281000	68 per pair





Accessories: 150K

! Charcoal grey upon request

Picture	Description	Item number light grey	Price € Color light grey
	Gutter end guard for 150K (per piece)	106071301	12
	Drain connection for 150K with drain connection NW 125, mud bucket, odor stop, and two gutter end guards	106071001	31.50

Accessories: 150V line

! Charcoal grey upon request

Picture	Description	Item number light grey	Price € Color light grey
	Gutter end guard for 150V line (per piece)	106081301	12
	Drain connection for 150V line with drain connection NW 125, mud bucket, odor stop, and two gutter end guards	106081001	31.50
	Lateral drain connection NW 125 for 150V line	106081101	14.50
	Catch basin for 150V line with gutter connection on one or two sides, with galvanized mud trap Size 500 x 430 mm (W x H) with 1 gutter end guard 150V line and drain connection ring NW 100 and odor stop		
	Catch basin without grating light grey	106084001	138
	Pressure-locked grating MW 30/30 class A 15	106050112	49.50
	Pressure-locked grating MW 30/10 class A 15	106050122	56
	pressure-locked grating MW 30/30 class B 125	106050252	68
	pressure-locked grating MW 30/10 class B 125	106050262	75
	Pressure-locked V2A grating MW 30/10 class	106050342	upon request!
	Longitudinal GRP bar grating class light grey 125	106050152	93
	Longitudinal GRP bar grating class charcoal grey 125	106050162	102.30
	with cast iron grating class C 250	106050602	75
	with cast iron grating class D 400	106050702	84.50
	Wood insert	106050952	12

Drainage gutters: 200F and 200V line, load class B 125-D 400

The new large PROFI gutters for the intake of large quantities of water. These WOLFA gutters with a nominal width of 210 mm are available with an installation height of 238 mm or as flat gutter with an installation height of only 98 mm! All gratings with fourfold security. Easy overlap plug connection. With extra sturdy 8-mm thick GRP edges or integrated, galvanized 4-mm steel edge (upon request).

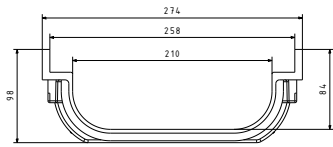

Drainage gutter 200F

Installation height 98 mm
Width 274 mm, inner width 210 mm
Length 1000 mm
Drain spout NW 125

8-mm GRP edges

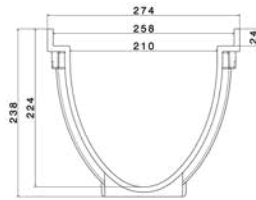

Drainage gutter 200V line

Installation height 238 mm
Width 274 mm, inner width 210 mm
Length 1000 mm
Drain spout NW 125

8-mm GRP edges

Color(s):



light grey

Gutter body without grating	Gutter length in mm	Pieces per pallet	Item number	Price €
200F without grating	1,000	40	107010101	78.50
	500		107010201	43
200V line without grating	1,000	24	107030101	92
	500		107030201	49.50

Please note:
All gutters come with grating

Gutter covers

! All gratings are screwed in place.



Pressure-locked grating
MW 30/30 | B 125







Pressure-locked grating
MW 30/10 | B 125







Cast iron grating
C 250 and D 400

Class	Grating variants	Gutter length in mm	Pieces per pallet	Item number	Price €
B 125	Pressure-locked grating MW 30/30	1,000	24	107050251	117
		500		107050252	76
	Pressure-locked grating MW 30/10	1,000		107050261	128
		500		107050262	83.50
C 250	Cast iron grating	-	-	-	-
		500	107050602	88	
D 400	Cast iron grating	-	-	-	-
		500	107050702	104	
	Wood insert	1,000	107050795	29	
500		107050796	16		

Accessories: 200F

Picture	Description	Item number	Price €
	Gutter end guard for 200F (per piece)	107061301	12
	Drain connection for 200F with discharge nozzle NW 125, mud bucket and odor stop and two gutter end guards	107061001	29
	Drain connection ring 125 NW 50 with lateral outlet	102056195	20.50
	Adapter for 200F catch basin	107073001	21
	Catch basin for 200F with gutter connection on one or both sides drain connection NW 150 or NW 200. Size 500 x 500 mm (L x H), with galvanized mud trap and one gutter end guard, price see 200V line	see 200V line below	

Accessories: 200V line

Picture	Description	Item number	Price €
	Gutter end guard for 200V line (per piece)	107081301	12
	Drain connection for 200V-Line with discharge nozzle NW 125, mud bucket and odor stop and two gutter end guards	107081001	34
	Lateral drain connection NW 150 for gutter 200V-Line	107081101	21
	Catch basin for 200V line with gutter connection on one or both sides drain connection NW 150 or NW 200. Size 500 x 500 mm (L x H), with galvanized mud trap and one gutter end guard		
	Catch basin without grating light grey	107084001	277
	Pressure-locked grating MW 30/30 class B125	107050252	76
	Pressure-locked grating MW 30/10 class B125	107050262	83.50
	Cast iron grating class C 250	107050602	88
	Cast iron grating class D 400	107050702	104
	Wood insert	107050796	16



Slot drain

The new WOLFA slot drain made of GRP is the most elegant solution when sophisticated architectural requirements need to be met. It allows an efficient channel drainage of facades, entrance areas, stairways, public places and other sealed surfaces. The 6-mm thick GRP edges guarantee permanent and corrosion-proof material durability.



Slot Drain:

The new WOLFA Slot Drain made of GRP is the most elegant solution when sophisticated architectural requirements need to be met. It allows an efficient channel drainage of facades, entrance areas, stairways, public places and other sealed surfaces.

Color(s):

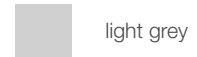

light grey



charcoal grey

Slot Drain: Type 100/6VS up to class C250

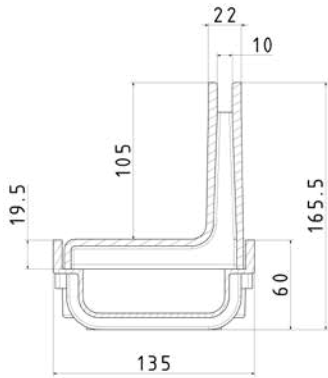

Item number	Variant	Price €
101000111	light grey, spring left	124
101000121	light grey, spring right	124
101000112	charcoal grey, spring left	136
101000122	charcoal grey, spring right	136

Size in mm (W x H):
Slit aperture: 10
Total: 135 x 165
Gutter length: 1,000

Slot Drain: Type 100/8VS up to class C250

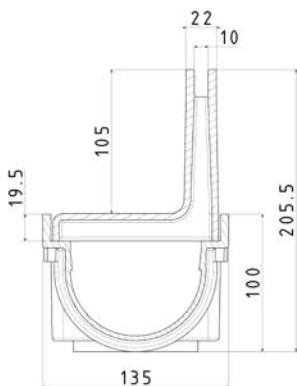

Item number	Variant	Price €
101000211	light grey, spring left	124
101000221	light grey, spring right	124
101000212	charcoal grey, spring left	136
101000222	charcoal grey, spring right	136

Size in mm (W x H):
Slit aperture: 10
Total: 135 x 205
Gutter length: 1,000

Slot Drain: Type 100VS line - up to class D400

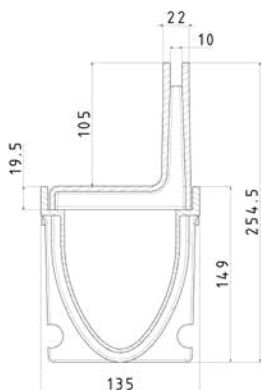

Item number	Variant	Price €
101000311	light grey, spring left	127
101000321	light grey, spring right	127
101000312	charcoal grey, spring left	139
101000322	charcoal grey, spring right	139

Size in mm (W x H):
Slit aperture: 10
Total: 135 x 254
Gutter length: 1,000

Accessories: Slot drains type 100/6VS + type 100/8VS + type 100VS line ! Color charcoal grey + 10% surcharge

Picture	Description	Item number light grey	Item number charcoal grey	Price € light grey
	Metal strips installed for 100/6V and 100/8V (2 pieces per, 1000 mm long)	104281100		7.50 per pair
	Elevation for slot drain with 100/6V or 100/8V for heights between 30 and 300 mm (2 pcs, 1000 mm each) only in connection with metal strips	104281000		57 per pair
	Catch basin with inspection cap, with 1 gutter end guard, with drain connection ring NW100 and oder stop, with galvanized mud trap, size 320 x 408 mm (L x H)	101001001	101001002	178
	Adapter 100/6V for catch basin	104063001	104063002	8
	Adapter 100/8V for catch basin	104073001	104073002	8
	Gutter end guard 100/6V	104061301	104061302	8
	Gutter end guard 100/8V	104071301	104071302	8
	Gutter end guard gutter 100V line	104081301	104081302	8
	Drain connection kit 100/6V	104061001	104061002	22.50
	Drain connection kit 100/8V	104071001	104071002	23
	Drain connection kit gutter 100V line	104081001	104081002	23
	Lateral drain connection 100V line	104081101	104081102	9
	Inspection cap for installation in gutter body	101011001	101011002	86
	Keys for inspection cap (2 pcs)	101011000		20.50 per pair

Accessories: For all gutter types

Picture	Description	Item number	Price €
	Teroson MS 930 cartridge for gutter joint waterproofing,	109990101	47



Entrance/exit ramps 150V line with cast iron grating



Garage doorway: 150V line with cast iron grating



Driveway: 100V line with longitudinal GRP bar grating, charcoal grey



Patios: Fixo 150 with pressure-locked grating 30/10



Entrance: Slot drain with catch basin and inspection cap, two keys



Facade and drainage gutters

WOLFA facade and drainage gutters made of galvanized steel or glass fiber reinforced polyester for particularly low installation heights. The absorbed water can be released into the environment through the slotted walls or drained away via a T-channel.

- Attractive look
- Walkable and wheelchair accessible
- Various grating covers
- Easy installation
- Resistant to de-icing salt and frost
- Easy to clean



NEW

Drainage gutter 100/6VD

For the intake, infiltration or drainage of surface water from patios and balconies, or other pedestrian surfaces. Gratings safe for pedestrians and wheelchair users.



Gutter body with drainage slots

Color(s):

- light grey
- charcoal grey (+ 10%)

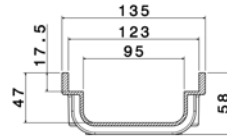

Gutter 100/6VD

Installation height 58 mm
Width 135 mm, inner width 95 mm
Drain spout NW 100 or NW 50 laterally

! Note



Drain connection ring NW 50 with lateral outlet

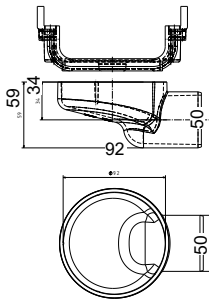

Gutter body without grating	Gutter length in mm	Pieces per pallet	Item number	Price €
100/6VD without grating, light grey	1,000	56	104020101	60.50
100/6VD without grating, charcoal grey	1,000		104020102	66.55

Gutter covers

Gratings	Gutter length in mm	Pieces per pallet	Item number	Price €
Slotted grating	1,000	56	104050101	18
Pressure-locked grating MW 30/30	1,000		104050111	25.50
Pressure-locked grating MW 30/10	1,000		104050121	35
Longitudinal GRP bar grating, light color	1,000		104050151	47
Longitudinal GRP bar grating, charcoal grey	1,000		104050161	51.70
Slotted GRP design grating, light color	1,000		104050131	39
Slotted GRP design grating, charcoal grey	1,000		104050141	42.90
V2A slotted grating	1,000		104050171	60.50
V2A perforated design grating	1,000		104050181	42.50
Longitudinal V2A bar grating	1,000		104050191	198
Plastic grating	500		104050302	15

Accessories: Drainage gutter 100/6VD

! Color charcoal grey + 10% surcharge

Picture	Description	Item number light grey	Item number charcoal grey	Price € light grey
	Metal strips mounted for 100/6VD (2 pieces, each 1000 mm long)	104281100		7.50 per pair
	Gutter end guard for 100/6VD (per piece)	104061301	104061302	8
	Drain connection NW100 for 100/6VD, complete with intake filter, odor stop and two lateral end guards	104061001	104061002	22.50
	Variable elbow piece 100/6VD for corner joint, T-joint or cross connection, two lateral end guards (length 305 mm) without grating, light grey	104061501	104061502	51
	Grating covers for variable elbow piece	see page 87		
	Elevation for 100/6VD for height fixation between 30 mm and 300 mm (2 pieces, each 1000 mm long) only together with metal strips Other heights upon request!	104281000		57 per pair
	Drain connection ring NW 50 with lateral outlet	104281200	104281300	20.50

AquaStop Ultra 150 - load class E 600

The perfect footbridge to patio and facade. The multi-channel gutter without grating is becoming increasingly fashionable in patio flooring thanks to its attractive look, low installation height and easy cleaning.

see our discounted group



Installation height 25 mm;
Width 150 mm;
Inner width 10 mm.

Color(s):

charcoal grey

	Gutter length in mm	Pieces per pallet	Item number	Price €
	1,000	60	102010040	78.50

AquaStop Drain 150

with drainage opening

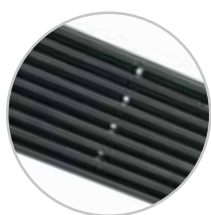

	Gutter length in mm	Pieces per pallet	Item number	Price €
	1,000	60	102010050	84.50

! Note

Straight intake filter with detachable inspection flap

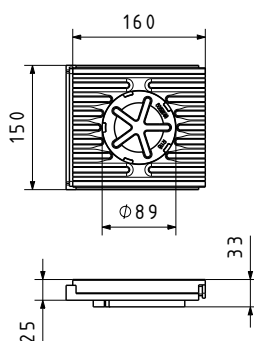

In the picture, the gutter was placed on drainage mortar and drilled open

Drain connection ring NW 50 with lateral outlet

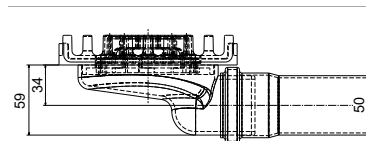
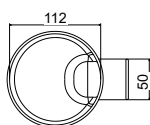

Accessories: AquaStop Ultra 150 / AquaStop Ultra 150

Picture	Description	Item number	Price €
	Variable elbow, straight, size 158mm x 158mm	102054540	93
	Intake piece, straight, size 160mm x 150mm	102054040	104
	Lateral gutter end guard for width 150 mm	102055040	5.50
	Terminating ring NW 50 with lateral outlet	102056195	20.50
	Drain connection ring NW 100 with odor stop	102056795	34.50



The picture shows Fixo 110 with slotted grating



The picture shows Fixo 150 with pressure-locked grating 30/10

Drainage gutter: Fixo 110

Steel box gutter, galvanized, for facade and patio drainage
Installation width 110 mm, installation height 75 mm, inner width 105 mm. Suitable for pedestrians and wheelchairs, with grating lock upon request.



Slotted grating



Pressure-locked grating MW 30/30



Pressure-locked grating MW 30/10



Fixo 150 picture with grating lock

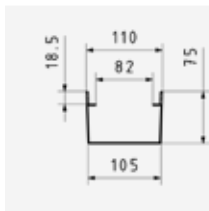

Grating variants	Gutter length in mm	Pieces per pallet	Item number	Price €
Metal gutter body without grating	1,000	56	108010101	83
Slotted grating	1,000	56	103050110	17
Pressure-locked grating MW 30/30	1,000	56	103050210	20.50
Pressure-locked grating MW 30/10	1,000	56	103050310	29

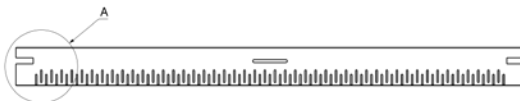

! Other installation heights upon request!

Drainage gutter: Fixo 150

Steel box gutter, galvanized, for facade and patio drainage. Installation width 150 mm, installation height 75 mm, inner width 145 mm. Gratings safe for pedestrians and wheelchair users. Grating lock upon request.

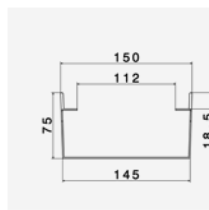

Grating variants	Gutter length in mm	Pieces per pallet	Item number	Price €
Metal gutter body without grating	1,000	56	108020101	108
Pressure-locked grating MW 30/30	1,000	56	108050210	25
Pressure-locked grating MW 30/10	1,000	56	108050310	38

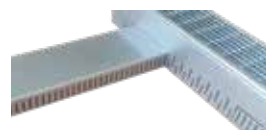

T-channel
Width x height x length in mm
100 x 30 x 1000

! Other installation heights upon request!

NEW: Lateral T-channel for Fixo 110 and Fixo 150

Accessories: Fixo 110 And Fixo 150

Picture	Description	Item number	Price €
	Gutter end plate for width 110 mm	108061301	23.50
	Gutter end plate for width 150 mm	108071301	29
	Grating lock Fixo 110 (2 pcs)	108067001	12
	Grating lock Fixo 150 (2 pcs)	108077001	13
	Lateral connecting piece for width 110 mm	108067501	7
	Lateral connecting piece for width 150 mm	108077501	8.50
	Lateral T-channel Fixo 110 and Fixo 150 Size: 100 mm x 30 mm x 1000 mm (width x height x length)	108097801	72.50

1
2
3
4
5
6
7
8
9
10
11
12
13
14
15
16
17
18

Spot intake/yard catch basin 25/25 - load class B 125

NEW

Available from end of march 2024

Complete with screwed-in-place plastic grating or inserted pressure-locked grating mesh size 30/10 and detachable mud trap, odor stop and drain connection NW100, drainage capacity approx. 4.5 l/sec.



GRP catch basin Grating	Size in mm (W x L x H)	Item number	Price €
Catch basin without grating light grey	250 x 250 x 235	109010010	117
Catch basin without grating charcoal grey	250 x 250 x 235	109010020	128.70
Plastic grating		109010100	28
Pressure-locked grating 30/10		109010200	57

Made of glass fiber reinforced polyester GRP. The alternative to heavy catch basin made of concrete or polymer concrete. With odor stop and drain connection element NW 100

Color(s):



Your advantages:

- attractive look
- car-trafficable
- low weight
- break-proof
- odor stop
- easy installation
- corrosion-resistant
- no clogging of the channel
- low installation costs

Areas of application:

For the intake and discharge of surface water, for example from yards, driveways, entrance areas, pedestrian areas, water tapping points, patios and basements.

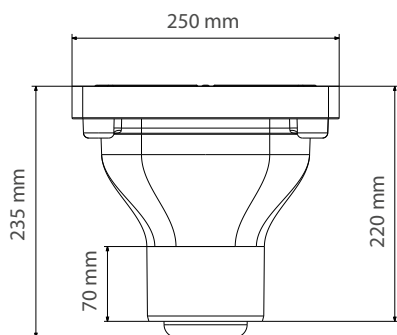

Installation example with 90° elbow piece DN 100

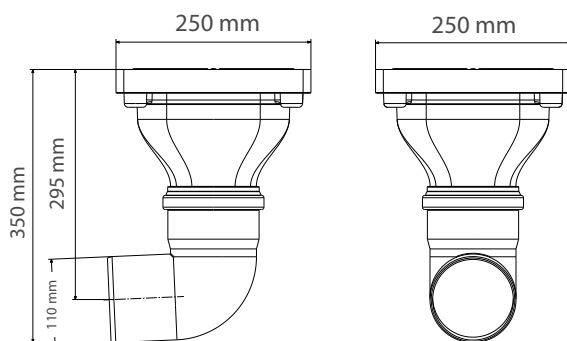

90° elbow not included in the scope of supply!

Point drainage /yard catch basin

Spot intake/yard catch basin 30/30 - load class B 125

Comes with screwed-in-place cast iron grating class B 125 and galvanized mud trap, odor stop and NW 100 drain connection.



GRP catch basin / cover grid	Size in mm (W x L x H)	Item number	Price €
Catch basin without grating, light grey	300 x 300 x 350	109020010	137
Catch basin without grating, charcoal grey	300 x 300 x 350	109020020	150.70
Cast iron grating	300 x 300 x 350	109020100	51

Made of glass fiber reinforced polyester GRP. The alternative to heavy catch basin made of concrete or polymer concrete. With odor stop and drain connection element NW 100

Color(s):

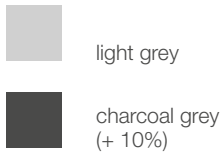

Your advantages:

- attractive look
- car-trafficable
- odor stop
- break-proof
- easy installation
- no clogging of the channel
- easy to keep clean
- low installation costs

Areas of application:

For the intake and discharge of surface water, for example from yards, driveways, entrance areas, pedestrian areas and water tapping points

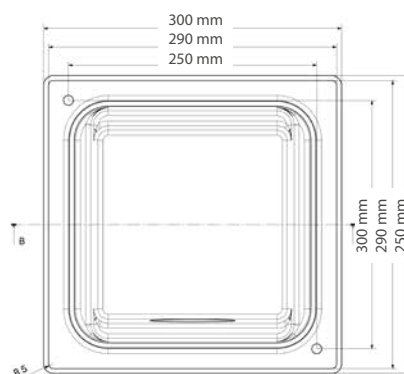
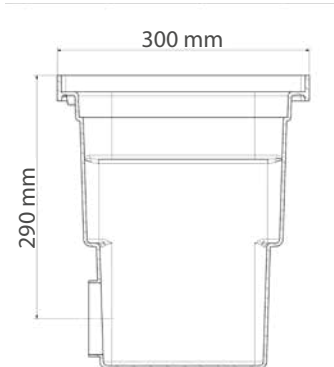
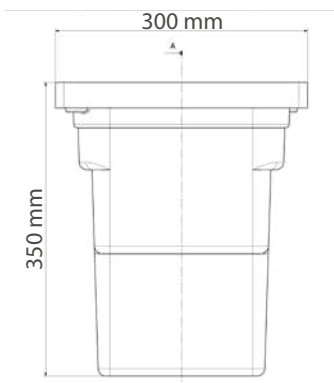



Barn windows and doors

The best choice for cattle barns and pigsties, horse and riding stables, and agricultural buildings WOLFA is among the pioneers in the use of glass fiber reinforced polyester in agricultural environments and has been manufacturing plastic barn windows for over 60 years. Being resistant to acid, extreme temperatures and all types of weather, the material is ideally suited for barns and stables. Our patented window sill ensures safe drainage of condensation water to the outside and thus dry walls.



Agriculture

104-113



Barn windows

106-107



Casement windows plus sizes

108-109



Doors from stainless steel V2A

110-111



Plastic gratings / feed troughs

112-113

NEW

GFK drainage gutters

84-87



Slotted GRP design grating, charcoal grey



Longitudinal GRP bar grating, light grey



Plastic barn windows: type F - pivoting sash

Robust, weather-resistant, maintenance-free and for over 60 years tried and tested all over the world. Encased pivoting sash and lever action, bottom pane patterned glass (raw glass), top pane transparent glass. Different opening positions possible.



Color(s):

- light grey
- brown (7% surcharge)



Type F with encased pivoting sash and lever action

Window frame and pivoting sash made from glass fiber reinforced polyester

! Joint for row of windows € 12

! Bottom pane transparent glass upon request Surcharge 10%

Type F

Top: 5-mm transparent glass, bottom: 5-mm raw glass.

Size in cm (W x H)	Price €
75 x 62.5	114
75 x 75	121
75 x 87.5	126
75 x 100	133
75 x 112.5	140
87.5 x 62.5	121
87.5 x 75	128
87.5 x 87.5	133
87.5 x 100	141
87.5 x 112.5	147
100 x 62.5	126
100 x 75	133
100 x 87.5	141
100 x 100	146
100 x 112.5	152
112.5 x 62.5	133
112.5 x 75	141
112.5 x 87.5	147
112.5 x 100	153
112.5 x 112.5	159
125 x 62.5	139
125 x 75	145
125 x 87.5	153
125 x 100	159
125 x 112.5	163



! Widths 94, 104,5 and 119 cm are also available in all heights. Prices as for the next largest standard size. Special measures upon request.

Accessories: special glazings

For all sizes.

Patterned glazing raw glass m ² / outer surface	28
Tempered single-pane safety glass ESG 5 mm m ² / outer surface	80

Accessories: plastic window sills

For all plastic barn window types.

Length in cm	Width 15 cm Incl. casement depth Wall thickness up to 24 cm	Width 22 cm Incl. casement depth Wall thickness of more than 24 cm
75	21	27
87.5	22	33
100	25	34
112.5	29	40
125	34	43

Plastic barn windows: type DEN 90, DN 90 – Hopper sash (tilt) window

Robust, weather-resistant, maintenance-free and for over 60 years tried and tested all over the world. Hopper sash with transparent glass (type DEN 90) or insulating glass (type DN 90). The sash fastener allows different opening positions.



Color(s):



light grey



brown
(7% surcharge)



Casement and hopper (tilt) sash made from glass fiber reinforced polyester

Type DEN 90 with 5-mm transparent glass

Type DN 90 with 15-mm insulating glass

The windows can be installed next or above each other as required.

! Joint for row of windows € 12

Type DEN 90

5-mm transparent glass

Size in cm (W x H)	Price €	Visible glass pane m ²
75 x 62.5	122	0.28
75 x 75	132	0.35
75 x 87.5	140	0.43
75 x 100	146	0.50
87.5 x 62.5	132	0.34
87.5 x 75	141	0.43
87.5 x 87.5	147	0.52
87.5 x 100	155	0.61
100 x 62.5	141	0.40
100 x 75	149	0.50
100 x 87.5	155	0.61
100 x 100	158	0.71
112.5 x 62.5	149	0.46
112.5 x 75	155	0.58
112.5 x 87.5	162	0.70
112.5 x 100	175	0.82
125 x 62.5	155	0.51
125 x 75	162	0.63
125 x 87.5	175	0.79
125 x 100	181	0.93

Type DN 90

15-mm insulated glass

Size in cm (W x H)	Price €	Visible glass pane m ²
75 x 62.5	165	0.28
75 x 75	170	0.35
75 x 87.5	176	0.43
75 x 100	193	0.50
87.5 x 62.5	170	0.34
87.5 x 75	176	0.43
87.5 x 87.5	205	0.52
87.5 x 100	217	0.61
100 x 62.5	176	0.40
100 x 75	191	0.50
100 x 87.5	211	0.61
100 x 100	226	0.71
112.5 x 62.5	187	0.46
112.5 x 75	205	0.58
112.5 x 87.5	231	0.70
112.5 x 100	249	0.82
125 x 62.5	202	0.51
125 x 75	214	0.63
125 x 87.5	240	0.79
125 x 100	260	0.93

! Widths 94, 104,5 and 119 cm are also available in all heights. Prices as for the next largest standard size. Special measures upon request.

Accessories: special glazings

For all sizes.

For type DEN: Patterned glazing raw glass m ² / outer surface	28
For type DN: Ornament Chinchilla, Silvit 178 m ² / outer surface	64
Tempered single-pane safety glass ESG 5 mm m ² / outer surface	80
Insulating glass / tempered single-pane safety glass ESG m ² / outer surface	88

Accessories: plastic window sills

For all plastic barn window types.

Length in cm	Width 15 cm Incl. casement depth Wall thickness up to 24 cm	Width 22 cm Incl. casement depth Wall thickness of more than 24 cm
75	21	27
87.5	22	33
100	25	34
112.5	29	40
125	34	43

Casement windows plus sizes **K** : agriculture and industry

Casement made of glass fiber reinforced polyester, Perfect for installations in concrete, optionally with plastic window inserts as fixed window pane, hopper sash PLUS Ug 1.2 W/m²K, hopper sash TOP or tilt & turn window with insulating glazing WOLFA-Therm Ug 1.1 W/m²K.

Color(s):  white

! Visible glass surface see page 109.



Type PLUS single sash
Hopper sash insert



Type MDK, two sashes
Tilt & turn insert



Type TOP, two sashes
Hopper sash (tilt) insert



Type FIB, one sash
Fixed window pane

PLUS – tilt Ug 1.2

MDK 58 – tilt & turn

TOP 58 - tilt

FIB 58 – fixed window pane

Size in cm (W x H) Wall width in cm	Price €
100 x 100	
30	357
36.5	367
39.5	371
125 x 100	
30	424
36.5	434
39.5	444
125 x 125	
30	458
36.5	474
39.5	485
150 x 100*	
30	445
36.5	451
39.5	458
150 x 125*	
30	477
36.5	485
39.5	493
200 x 100*	
30	580
36.5	587
39.5	593
200 x 125*	
30	616
36.5	622
39.5	629
225 x 100*	
30	621
36.5	627
39.5	634
225 x 125*	
30	661
36.5	668
39.5	675
250 x 100*	
30	664
36.5	671
39.5	679
250 x 125*	
30	700
36.5	706
39.5	731

Size in cm (W x H) Wall width in cm	Price €
100 x 100	
30	473
36.5	483
39.5	487
125 x 100	
30	600
36.5	610
39.5	620
125 x 125	
30	679
36.5	695
39.5	706
150 x 100*	
30	756
36.5	762
39.5	769
150 x 125*	
30	795
36.5	803
39.5	811
200 x 100*	
30	826
36.5	833
39.5	839
200 x 125*	
30	879
36.5	885
39.5	892
225 x 100*	
30	882
36.5	888
39.5	895
225 x 125*	
30	936
36.5	943
39.5	950
250 x 100*	
30	941
36.5	948
39.5	956
250 x 125*	
30	993
36.5	999
39.5	1006

Size in cm (W x H) Wall width in cm	Price €
100 x 100	
30	377
36.5	387
39.5	391
125 x 100	
30	443
36.5	453
39.5	463
125 x 125	
30	474
36.5	490
39.5	501
150 x 100*	
30	466
36.5	472
39.5	479
150 x 125*	
30	498
36.5	506
39.5	514
200 x 100*	
30	597
36.5	604
39.5	610
200 x 125*	
30	640
36.5	646
39.5	653
225 x 100*	
30	643
36.5	649
39.5	656
225 x 125*	
30	675
36.5	682
39.5	689
250 x 100*	
30	678
36.5	685
39.5	693
250 x 125*	
30	709
36.5	715
39.5	722

Size in cm (W x H) Wall width in cm	Price €
100 x 100	
30	351
36.5	361
39.5	365
125 x 100	
30	403
36.5	413
39.5	423
125 x 125	
30	427
36.5	443
39.5	454
150 x 100	
30	420
36.5	426
39.5	433
150 x 125	
30	449
36.5	457
39.5	465
200 x 100*	
30	501
36.5	508
39.5	514
200 x 125*	
30	534
36.5	540
39.5	547
225 x 100*	
30	542
36.5	548
39.5	555
225 x 125*	
30	571
36.5	578
39.5	585
250 x 100*	
30	575
36.5	582
39.5	590
250 x 125*	
30	606
36.5	612
39.5	619

* two sashes

Casement plus sizes: type ZO agriculture and industry

Sizes in cm / Wall thickness in cm	Price €	Sizes in cm / Wall thickness in cm	Price €	Sizes in cm / Wall thickness in cm	Price €	Sizes in cm / Wall thickness in cm	Price €
100 x 100		150 x 100		200 x 125		250 x 100	
30	154	30	210	30	260	30	280
36.5	164	36.5	216	36.5	266	36.5	287
39.5	168	39.5	223	39.5	273	39.5	295
125 x 100		150 x 125		225 x 100		250 x 125	
30	192	30	229	30	261	30	297
36.5	202	36.5	237	36.5	267	36.5	303
39.5	212	39.5	245	39.5	274	39.5	310
125 x 125		200 x 100		225 x 125			
30	210	30	243	30	278		
36.5	226	36.5	250	36.5	285		
39.5	237	39.5	256	39.5	292		



Color(s): white

Window inserts plus sizes agriculture and industry

Sizes in cm / window insert	Price €	Size in cm / window insert	Price €	Size in cm / window insert	Price €	Size in cm / window insert	Price €
100 x 100		150 x 100		200 x 125		250 x 100	
ZO-PLUS	203	ZO-PLUS*	235	ZO-PLUS*	356	ZO-PLUS*	384
ZO-MDK	219	ZO-MDK*	546	ZO-MDK*	619	ZO-MDK*	661
ZO-TOP	223	ZO-TOP*	256	ZO-TOP*	380	ZO-TOP*	398
ZO-FIB	197	ZO-FIB	210	ZO-FIB*	274	ZO-FIB*	295
125 x 100		150 x 125		225 x 100		250 x 125	
ZO-PLUS	232	ZO-PLUS*	248	ZO-PLUS*	360	ZO-PLUS*	403
ZO-MDK	408	ZO-MDK*	566	ZO-MDK*	621	ZO-MDK*	696
ZO-TOP	251	ZO-TOP*	269	ZO-TOP*	382	ZO-TOP*	412
ZO-FIB	211	ZO-FIB	220	ZO-FIB*	281	ZO-FIB*	309
125 x 125		200 x 100		225 x 125			
ZO-PLUS	248	ZO-PLUS*	337	ZO-PLUS*	383		
ZO-MDK	469	ZO-MDK*	583	ZO-MDK*	658		
ZO-TOP	264	ZO-TOP*	354	ZO-TOP*	397		
ZO-FIB	217	ZO-FIB*	258	ZO-FIB*	293		



type PLUS Ug 1.2 – hopper sash (tilt) insert
2 sashes from 150 cm



Type MDK 58 - tilt & turn sash
2 sashes from 150 cm



Type TOP 58 - hopper sash insert
2 sashes from 150 cm



Type FIB 58 - fixed window pane
2 sashes from 200 cm

* two sashes

Visible glass pane in m²:

Size in cm (W x H)	Visible glass pane in m ² version			
	Hopper sash PLUS	Tilt & turn sash MDK	Hopper sash TOP	Fixed window pane
100 x 100	0.54	0.50	0.50	0.62
125 x 100	0.73	0.67	0.67	0.81
125 x 125	0.97	0.91	0.91	1.07
150 x 100	0.79*	0.71*	0.71*	1.01
150 x 125	1.07*	0.96*	0.96*	1.33
200 x 100	1.16*	1.06*	1.06*	1.31*
200 x 125	1.56*	1.44*	1.44*	1.73*
225 x 100	1.35*	1.24*	1.24*	1.51*
225 x 125	1.80*	1.68*	1.68*	1.99*
250 x 100	1.53*	1.41*	1.41*	1.71*
250 x 125	2.05*	1.92*	1.92*	2.25*

* two sashes

Product information on:
ZO-PLUS see page 30- 31
ZO-MDK see page 29
ZO-TOP see page 32
ZO-FIB see page 33

Accessories casement windows
see pages 36-38.

Exterior doors Made of V2A stainless steel and tailored to the customer's requirements!

Exterior door with 40-mm polyester sandwich panel

Frame, wing casement and fittings made of brush-finished V2A stainless steel
 Plastic handles (standard: knobs on both sides), upon request of stainless steel
 EPDM gasket
 Panel thickness 40 mm, optionally 60 mm or 80 mm.
 Door saddle at buyer's option
 Upon request with glazing, insulating glass, size 600 x 600 mm or 600 x 800 mm
 Upon request with combination lock
 Maximum door size 1400 x 3000 mm
 Colors: fir green RAL 6009, charcoal grey 7016, traffic white RAL 9016
 Standard interior color is white. Other colors upon request.



Number of wings	Up to size in mm	Price €
Single sash	1000 x 2125	Prices upon request!
Single sash	1400 x 2600	
Double sash	2000 x 2125	
Double sash	2800 x 2600	
Surcharge for stainless steel handle set		
Surcharge for profile cylinder lock		
Surcharge for knob cylinder lock		
Door glazing size 600 x 800 mm		

Door saddles:

	Montagewinkel	Standardschwelle	Niedrige Schwelle
A (Höhe)	20 mm	70 mm	20 mm
B (Breite)	60 mm	65 mm	65 mm

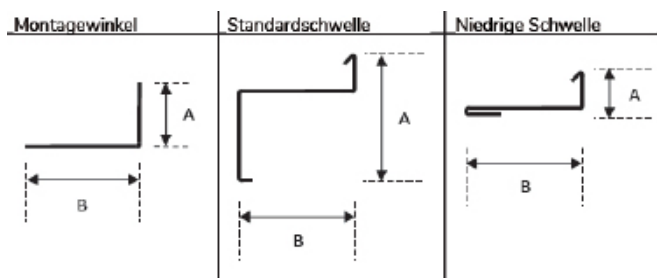

Interior doors: Made of V2A stainless steel and tailored to the customer's requirements!

Interior door with 40-mm PVC sandwich panel

Frame, wing casement and fittings made of brush-finished V2A stainless steel
 Plastic handles (standard: knobs on both sides), upon request of stainless steel
 EPDM gasket

Panel thickness 40 mm, optionally 60 mm or 80 mm.

Door saddle at buyer's option

Upon request with Plexiglas glazing size 300 x 600 mm with black plastic casement

Maximum door size 1400 x 3000 mm

Colors: light grey RAL 7035, traffic white RAL 9016

Standard interior color is white. Other colors upon request.

Number of wings	Up to size in mm	Price €
Single sash	1000 x 2125	Prices upon request!
Single sash	1200 x 2550	
Single sash	1400 x 2800	
Double sash	2000 x 2125	
Double sash	2400 x 2500	
Double sash	2800 x 2800	
Surcharge for stainless steel handle set		
Surcharge for profile cylinder lock		
Surcharge for knob cylinder lock		
Door glazing size 300 x 600 mm		

PVC colors:

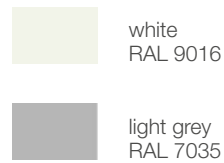

Single wing door

A	Frame width	Opening measure + 85 mm
B	Passage width	Opening measure - 58 mm
C	Opening measure	up to 1400 mm
D	Wall thickness	possible from 40 mm
E	Frame rebate	50 mm wide

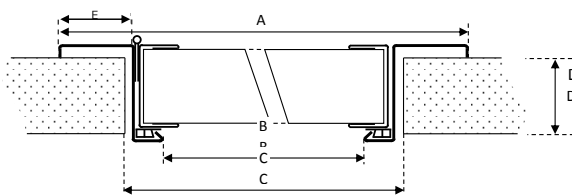

Double sash door

A	Frame width	Opening measure + 85 mm
B	Passage width	Opening measure - 58 mm
C	Opening measure	up to 2900 mm
D	Wall thickness	possible from 35 mm

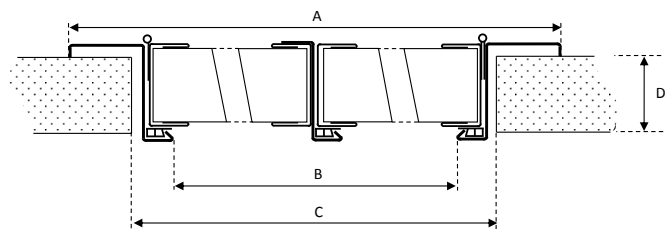

1 Plastic gratings: agriculture and industry

Plastic gratings made of glass fiber reinforced polyester for industrial and agricultural purposes.

Installation height: 50 mm

Color(s):



brown

2

3

4

5

6

7

8

9

10

11

12

13

14

15

16

17

18



Type I:

Slot size 90 x 9 mm

Size in cm (W x H)	Price €
80 x 33.3	54
100 x 33.3	62
120 x 33.3	72
140 x 33.3	83

(! Type I: for farrowing pens, sheep and goats).



Type II:

Slot size 86 x 12 mm.

Size in cm (W x H)	Price €
80 x 33.3	54
100 x 33.3	62
120 x 33.3	72
140 x 33.3	83

(! Type II: for pig rearing, sheep and goats).



Type III:

Slot size 86 x 17 mm.

Size in cm (W x H)	Price €
80 x 33.3	54
100 x 33.3	62
120 x 33.3	72

(! Type III: for pig fattening, and empty sow husbandry)



Type IV:

Slot size 86 x 23 mm.

Size in cm (W x H)	Price €
80 x 33.3	54
100 x 33.3	62
120 x 33.3	72



Type V:

Slot size 31 x 9 mm.

Size in cm (W x H)	Price €
80 x 33.3	54
100 x 33.3	62
120 x 33.3	72
140 x 33.3	83

(! Type V: for bedding (straw, etc.)).



Type IV:

Slot size 90 x 9 mm.

Size in cm (W x H)	Price €
80 x 50	69
90 x 50	77
100 x 50	83
110 x 50	92
120 x 50	98
130 x 50	105
140 x 50	116

(! Type IV: for piglets).



Plastic feed troughs: for pigs

Made of glass fiber reinforced polyester.

Color(s):



Size in cm (W x H)	Price €
100 x 40	56
100 x 47	62

Separator end piece:

Size in cm	Price
40	16
47	19

Plastic feed mangers: for cattle

Made of glass fiber reinforced polyester.

Color(s):



Type I:

Size in cm (L x W x H)	Price €
100 x 60 x 16	63

Separator end piece:

	End piece for type (can be used right and left) 19
--	---



Type II:

Size in cm (L x W x H)	Price €
100 x 50 x 16	60

Type II A:

Size in cm (L x W x H)	Price €
100 x 60 x 16	62





Residential windows

The windows and doors made by WOLFA make your home the most comfortable ever. They consist of multi-chamber PVC profiles with steel reinforcements and insulating glass which guarantee highest possible energy efficiency. WOLFA also manufactures and supplies special insulation glasses. Thanks to their fully automatic window production lines, WOLFA warrants highly precise sizes and fast production times at fair prices.



Product information 114

Single sash tilt & turn 117

Double sash tilt & turn 118

One-piece fixed 119

Patio door - single wing 120

Patio door- double wing 120

Back doors 121

Options 121

WOLFA anti-burglary system 122

Decor overview 123

Front doors 124

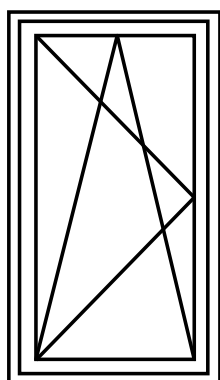
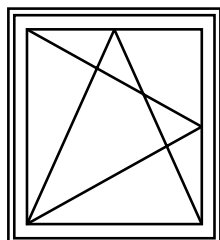

1
2
3
4
5
6
7
8
9
10
11
12
13
14
15
16
17
18

Product information:

Plastic windows Softline with an installation depth of 70 mm or 82 mm. Versions with offset surfaces with double window rebate seals, galvanized steel fittings in casement and sash, anti-burglary mushroom pin lock fittings type Roto NX.



SOFTLINE 82

82 mm installation depth

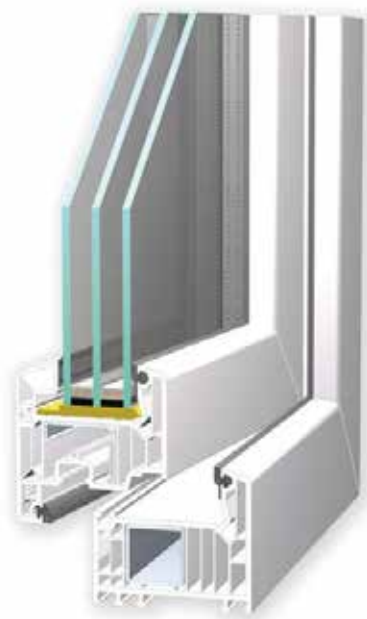

- Highest quality: Class A profile according to DIN EN 12608
- 82-mm profile depth - ideal for effective heat insulation, Insulation, suitable for new buildings and renovations
- 7-chamber profile for optimum energy efficiency
- Creative window design: Different shapes and colors
- Triple glazing $U_g=0,6 \text{ W/m}^2\text{k}$ with warm-edge bond, $U_w\text{-value} = 0.85 \text{ W/m}^2\text{K}$
- Large and perfectly fitted steel fittings in casement and sash
- Anti-burglary mushroom pin lock with two additional safety lock elements for basic security

SOFTLINE 70

70 mm installation depth



- Highest quality Class A profile according to DIN EN 12608
- 70-mm profile depth - ideal for effective heat insulation, suitable for new buildings and renovations
- 5-chamber profile for high energy efficiency
- Creative window design: Colors
- Double glazing $U_g=1.1 \text{ W/m}^2\text{k}$, $U_w\text{-value} = 1.3 \text{ W/m}^2\text{k}$
Triple glazing $U_g=0.7 \text{ W/m}^2\text{k}$, $U_w\text{-value} = 1.1 \text{ W/m}^2\text{k}$ with thermal edge bond $U_w\text{-value} = 1.0 \text{ W/m}^2\text{k}$
- Large and perfectly fitted steel fittings in casement and sash
- Anti-burglary mushroom pin lock with two additional safety lock elements for basic security

Product information: see page 116

Prices for **70-mm** installation depth Softline (insulating glass WOLFA-Therm Ug 1.1)

Prices for **82-mm** installation depth Softline (triple-paned insulating window WOLFA-Therm Ug 0.6)

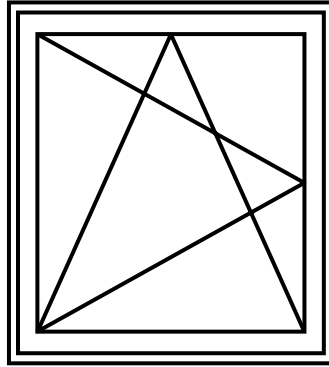

Single-sash window
tilt & turn

Color(s):

white
(similar to RAL 9016)

Example price calculation:
Window size 106 x 118 cm
(Width x Height) prices equal
next largest size
111.5 x 124 cm.
70 mm installation depth = €467
82 mm inst. depth = €686

Width in cm up to ▶	49	61.5	74	86.5	99	111.5	124	136.5	149	161.5
Height in cm to ▼	Price €									
49	295	318	328	336	344	357	395	405	411	429
	332	356	382	413	432	467	501	535	561	589
61.5	314	334	340	347	356	373	420	426	433	450
	354	385	413	446	476	501	534	575	604	633
74	319	339	347	356	371	394	430	437	458	475
	382	414	449	482	514	548	581	616	648	679
86.5	328	342	357	371	386	409	446	456	477	497
	414	446	479	510	541	578	610	653	688	723
99	342	360	373	398	413	443	461	475	500	522
	442	473	511	540	577	615	656	691	732	768
111.5	360	376	392	409	430	450	483	500	522	545
	466	507	543	575	610	644	689	735	773	814
124	366	383	406	427	447	467	493	525	551	575
	495	530	571	610	647	686	728	779	822	866
136.5	378	402	425	443	466	496	522	548	577	604
	518	560	603	640	682	732	775	822	871	916
149	394	414	440	464	488	519	545	575	603	630
	542	584	630	674	718	770	817	868	916	965
161.5	409	431	458	481	507	539	569	599	628	657
	569	612	661	705	753	808	860	912	962	1013
174	425	450	475	501	528	564	592	625	657	688
	594	644	658	740	790	849	900	958	1012	1066
186.5	438	466	491	519	546	583	610	651	682	716
	618	670	720	772	824	884	936	1001	1058	1116

Accessories residential windows see page 121- 122.

Triple-paned insulating window for 70 mm installation depth:

Surcharge for all Softline sizes = €33 m²/outer surface (net price)
(triple-paned insulating window Ug 0.7).

1 Product information: see page 116

2 Plastic window with 70-mm or 82-mm installation depth, offset surfaces, galvanized steel-reinforced casements and sashes, anti-burglary mushroom pin lock fittings Roto NX.

3 Prices for **70-mm** installation depth Softline (insulating glass WOLFA-Therm Ug 1.1)

Prices for **82-mm** installation depth Softline (triple-paned insulating window WOLFA-Therm Ug 0.6)

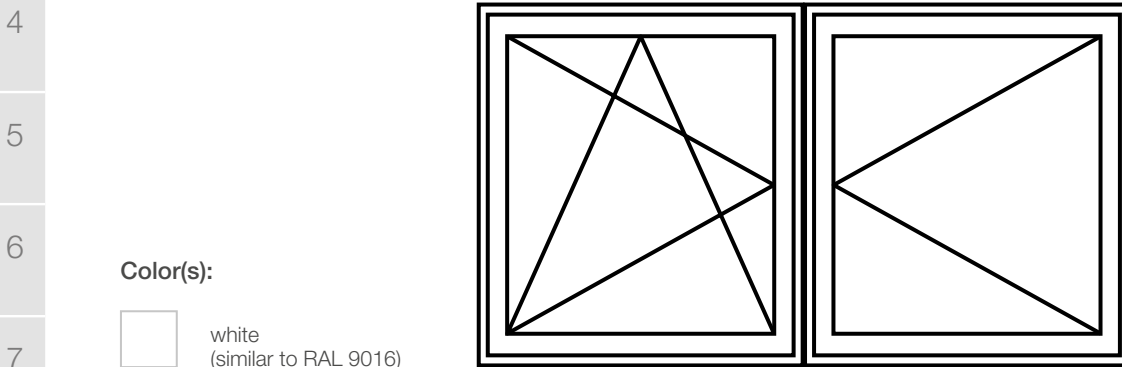

Double-sash window
tilt & turn / tilt & turn or
tilt & turn / turn

Example price calculation:

Window size 106 x 118 cm
(Width x Height) prices equal
next largest size
111.5 x 124 cm.
70-mm installation depth = € 703
82 mm inst. depth = € 979

Width in cm up to ▶	111.5	124	136.5	149	161.5	174	186.5	199	211.5	224	236.5	249	261.5	274	286.5	299
Height in cm to ▼	Price €															
61.5	574	586	597	613	625	642	658	674	712	729	743	760	779	796	811	827
	743	766	787	815	839	868	895	923	972	1001	1025	1054	1084	1115	1140	1168
74	597	610	624	641	656	677	683	712	750	770	780	797	816	834	853	873
	786	813	839	869	896	930	959	990	1042	1075	1098	1128	1159	1189	1221	1255
86.5	622	632	650	669	682	702	715	733	775	793	811	830	850	868	890	908
	833	856	888	923	948	983	1008	1042	1098	1131	1163	1195	1229	1262	1298	1329
99	646	659	681	700	710	729	750	772	813	831	850	871	888	908	932	953
	888	907	943	979	1002	1038	1049	1110	1168	1201	1237	1272	1304	1275	1379	1415
111.5	680	697	716	734	747	773	780	813	851	877	891	913	935	954	979	999
	933	967	1003	1038	1067	1108	1144	1182	1239	1280	1311	1350	1387	1425	1466	1502
124	703	718	735	760	776	798	820	843	884	907	921	944	970	993	1022	1043
	979	1012	1047	1088	1123	1163	1201	1243	1303	1343	1375	1460	1500	1547	1588	
136.5	731	746	768	791	808	834	851	875	916	942	965	984	1016	1040	1071	1096
	1028	1061	1104	1145	1181	1226	1264	1305	1367	1412	1453	1493	1543	1511	1637	1681
149	758	773	797	1145	842	869	890	915	959	984	1008	1035	1064	1090	1118	1137
	1077	1111	1157	1204	1242	1290	1331	1377	1441	1488	1531	1578	1628	1675	1723	1763
161.5	787	802	828	855	875	904	923	953	995	1023	1048	1075	1107	1134	1163	1192
	1128	1163	1212	1261	1302	1352	1392	1444	1508	1558	1606	1654	1709	1757	1808	1858
174	820	834	860	888	910	942	962	993	1037	1067	1093	1122	1158	1187	1218	1187
	1182	1218	1268	1319	1363	1418	1461	1514	1583	1636	1684	1736	1797	1849	1902	1954
186.5	848	865	889	918	943	974	996	1028	1075	1104	1131	1164	1201	1232	1262	1294
	1232	1272	1320	1374	1422	1479	1524	1579	1653	1706	1758	1815	1878	1932	1986	2044

16 **Accessories** residential windows see page 121- 122.

17 **Triple-paned insulating window for 70 mm installation depth:**

Surcharge for all Softline sizes = €33 m²/outer surface (net price)
(triple-paned insulating window Ug 0.7).

18

Product information: see page 116

Plastic window with 70-mm or 82-mm installation depth, galvanized steel-reinforced casements.

Prices for **70-mm** installation depth Softline or (insulating glass WOLFA-Therm Ug 1.1)

Prices for **82-mm** installation depth Softline (triple-paned insulating window WOLFA-Therm Ug 0.6)

Color(s):

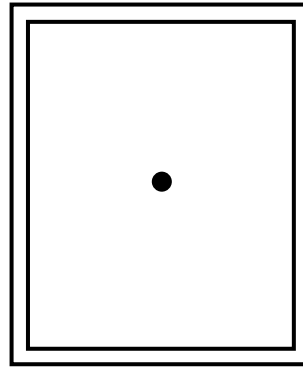

One-piece window,
fixed

Accessories residential windows
see pages 121-122.

Example price calculation:
see page 118.

Width in cm up to ▶	49	61.5	74	86.5	99	111.5	124	136.5	149	161.5	174	187	199	212	224
Height in cm to ▼	Price €														
49	155	165	170	178	190	198	207	219	229	242	251	261	275	286	296
	217	238	245	269	291	310	328	350	371	392	413	432	456	478	497
61.5	165	178	182	192	200	211	222	232	246	257	270	281	293	305	318
	238	261	277	298	318	339	361	383	408	430	454	477	500	523	548
74	169	180	189	202	215	227	240	252	263	279	292	305	320	332	347
	251	274	300	321	347	372	396	421	446	473	500	524	552	576	604
86.5	175	188	202	210	223	234	249	262	274	290	305	320	336	350	363
	267	293	321	343	369	395	423	450	475	505	534	563	592	621	647
99	185	199	214	225	237	250	261	280	296	309	328	345	360	378	395
	286	316	345	372	397	426	453	487	518	546	581	612	642	675	706
111.5	196	214	227	238	252	263	279	302	314	334	350	366	388	406	420
	308	342	372	397	429	456	404	526	555	593	625	657	696	729	761
124	206	221	238	249	266	281	303	322	338	356	378	398	417	433	453
	327	360	394	423	458	490	530	568	600	636	676	714	750	787	822
136.5	216	229	251	263	280	299	321	340	359	385	403	425	443	467	489
	348	380	420	452	487	524	566	603	641	687	723	764	802	845	885
149	229	245	266	280	297	326	340	359	383	403	420	448	471	495	517
	371	406	448	482	519	569	609	641	686	726	764	811	855	900	942
161.5	242	256	280	293	312	333	357	379	401	446	485	514	540	566	593
	392	429	475	510	548	590	638	681	723	791	854	904	952	1000	1048
174	251	272	297	310	333	353	378	403	430	479	516	576	627	662	698
	413	455	505	540	584	628	676	723	773	848	907	993	1066	1125	1185
186.5	261	283	307	325	348	369	400	426	450	514	583	627	667	700	732
	432	478	525	569	615	661	715	766	815	904	999	1067	1133	1192	1247
199	274	295	320	342	363	388	418	443	471	542	630	668	698	734	785
	455	501	551	599	645	696	751	802	854	954	1071	1134	1191	1252	1329
211.5	286	310	333	351	380	408	442	466	504	570	667	705	734	795	851
	478	528	577	622	677	732	793	844	908	1003	1130	1197	1252	1342	1426
224	296	325	350	369	398	430	464	489	525	601	702	743	795	856	900
	497	554	607	653	711	770	832	885	950	1057	1189	1258	1340	1431	1502
236.5	309	336	363	388	420	452	488	520	553	636	743	791	848	896	925
	520	576	633	687	749	809	874	936	999	1115	1253	1332	1419	1497	1556

Triple-paned insulating window for 70-mm installation depth see page 118

1 Product information: see page 116

Patio doors: single sash - tilt & turn

2 Patio door, white (similar to RAL 9016) with 70-mm or 82-mm installation depth, offset surfaces, galvanized steel fittings in casement and sash, anti-burglary mushroom pin lock fittings type Roto NX.

3 Prices for **70-mm** installation depth Softline (insulating glass WOLFA-Therm Ug 1.1)

Prices for **82-mm** installation depth Softline (triple-paned insulating window WOLFA-Therm Ug 0.6)

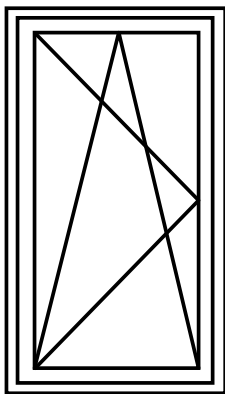

8 Single-wing patio door
tilt & turn

Width in cm up to ▶	74	86.5	99	111.5	124	136.5
Height in cm to ▼	Price €					
199	555	586	621	653	691	716
	798	855	915	973	1037	1088
211.5	578	605	639	679	716	741
	835	889	949	1016	1081	1133
224	609	635	663	704	743	774
	880	933	989	1059	1125	1185
236.5	628	660	689	723	766	796
	910	973	1031	1094	1166	1227
249	642	677	711	745	787	821
	938	1003	1067	1133	1206	1270

Example price calculation: see page 118.

9 **Accessories** residential windows
see pages 121-122.

Triple-paned insulating window for 70-mm installation depth see below.

Patio doors: Double-sash - tilt & turn

10 Patio door, white (similar to RAL 9016) with 70-mm or 82-mm installation depth, offset surfaces, galvanized steel fittings in casement and sash, anti-burglary mushroom pin lock fittings type Roto NX.

11 Prices for **70-mm** installation depth Softline (insulating glass WOLFA-Therm Ug 1.1)

Prices for **82-mm** installation depth Softline (triple-paned insulating window WOLFA-Therm Ug 0.6)

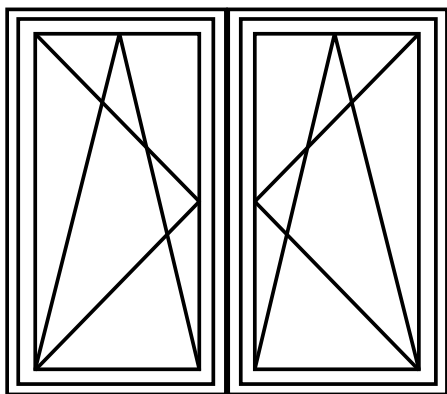

16 Double-wing patio door
Tilt & turn / tilt & turn or tilt & turn / turn

Width in cm up to ▶	124	136	149	161.5	174	186.5	199	211.5	224	236.5
Height in cm to ▼	Price €									
199	924	955	985	1013	1048	1086	1139	1160	1193	1222
	1356	1413	1468	1521	1583	1645	1705	1773	1831	1885
211.5	953	983	1018	1043	1078	1124	1158	1204	1239	1268
	1408	1465	1526	1578	1641	1713	1774	1849	1910	1967
224	982	1013	1051	1075	1111	1157	1194	1241	1217	1247
	1459	1519	1584	1636	1701	1775	1841	1916	1982	2041
236.5	1012	1046	1086	1108	1149	1193	1232	1286	1323	1355
	1512	1576	1645	1616	1767	1841	1909	1994	2061	2123
249	1043	1076	1117	1141	1182	1228	1268	1323	1363	1396
	1566	1630	1701	1757	1827	1905	1977	2064	2135	2198

Example price calculation: see page 118.

17 **Accessories** residential windows
see pages 121-122.

Triple-paned insulating window for 70 mm installation depth:

Surcharge for all Softline sizes = €33 m²/outer surface (net price)
(triple-paned insulating window Ug 0.7).

Product information: see page 116

Back doors Windows and doors in a harmonious look

WOLFA offers a variety of matching back doors and plastic windows.

Standard equipment and technology

- **Door casements and wings:** SL 70 or SL 82 profile
- **Filling:** insert panel
- **Heat insulating glass:** Double WOLFA-Therm®, Ug = 1.1 W/m²k or triple WOLFA-Therm® Ug=0.6
- **Lock/fittings:** GU-SECURITY, latchbolt, deadbolt and 2 massive bolts
- **Profile cylinder:** emergency and danger function, 3 keys
- **Inner - and outer handle:** narrow shield door handle set, **door hinges:** 3 stable door hinges, three-dimensionally adjustable

Standard models

Prices upon request!

please indicate:

- Size
- Pattern inside/outside
- Glass cutout or closed panel filling



Accessories: Additional profiles

On more than 500 pages, our catalog provides a vast range of interface profiles and accessories.

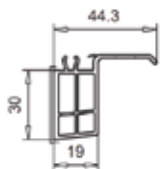

Window sill interface profile
30 mm / rm €7

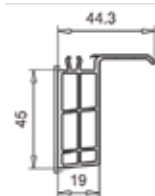

Window sill interface profile
45 mm / rm €10

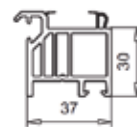

Window sill interface profile for new buildings
30 mm / rm €12.50



Cover caps
€6/pair

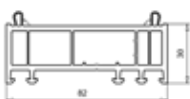

Casement enlargement
30 mm x 82 mm / rm € 22.50

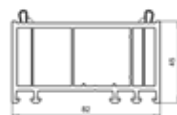

Casement enlargement
45 mm x 82 mm / rm € 23.50

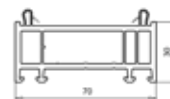

Casement enlargement
30 mm x 70 mm/ rm € 21.50

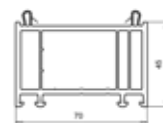

Casement enlargement
45 mm x 70 mm / rm € 22.50

1 Product information: see page 116

WOLFA anti-burglary system

Additional equipment for individual requirements

2



All WOLFA residential windows are equipped with ROTO NX mushroom pin lock and two safety lock elements for basic security.

For even more security, WOLFA provides an anti burglary kit with additional safety locks and pins which are directly bolted to the steel bracings, with drill protection and with lockable window handle.

3

4



Drill protection



Additional safety lock pins



Additional safety lock elements



Lockable window handle



Laminated safety glass (VSG) 6 mm

5

6

7

WOLFA anti burglary kit for residential windows

8



Anti-drill protection, Additional safety lock pins (dep. on size)
Additional safety lock elements (dep. on size)
Lockable window handle and laminated safety glass (VSG) 6 mm

Price upon request!

9

Patterns: Windows and doors with the same look

10

11



12

13

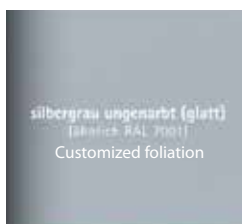

14

15

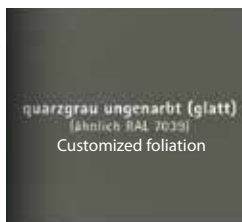
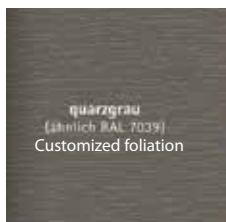





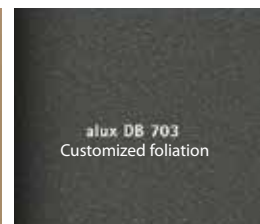
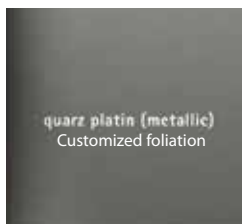







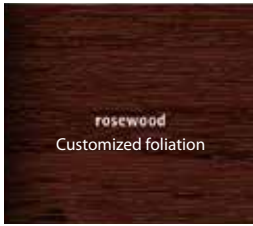









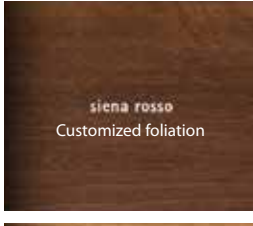
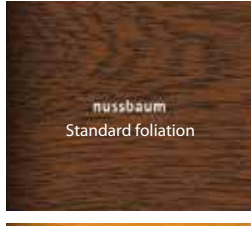
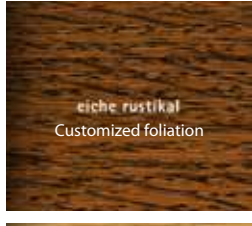

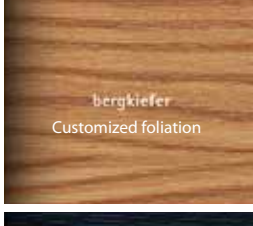

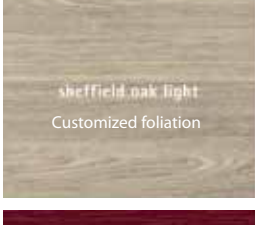



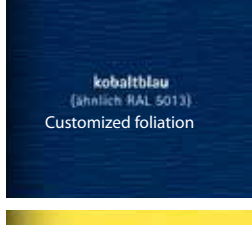
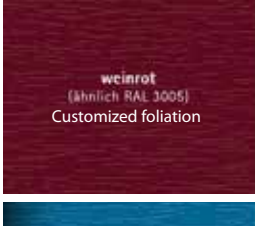
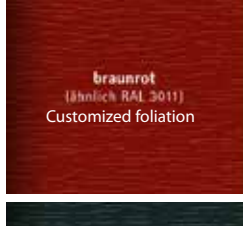
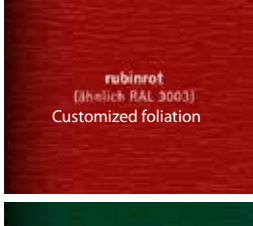

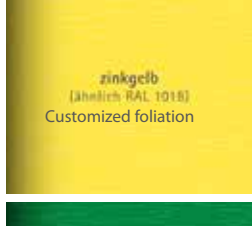
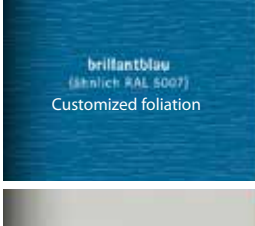
16

17

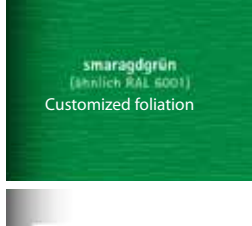

18

Accessories: Color surcharge Standard foils: Both sides +20 % One side +12 %
 Special foils: Both sides 25 % One side 15 %

					1
					2
					3
					4
					5
					6
					7
					8
					9
					10
					11
					12
					13
					14
					15
					16
					17
					18



Front doors

Our diverse selection of stylish entrance doors leaves nothing to be desired. On 200 pages, we present very attractive looking entrance doors in classic and modern styles. We would also be very happy to plan your entrance door and build it according to your ideas. You can find our current catalogs on our website at www.wolfa.de in the download area or simply contact us: Phone: 0049 (0) 79 34 / 91 91 0.



Front doors: single sash

Frame with five-chamber or seven-chamber profile with solid steel fittings, Winkhaus fittings with multi-point locks (safety door lock and strong swing bolt on top and bottom). Our range of high-quality door panels includes various collections with different configuration options from classic to modern - to suit every architectural style.



Our latest catalogs:

„Klassik“ and „Modern“

on our website

www.wolfa.de in the download area

Standard equipment and technology

- **Door casements and wings:** Choose between our profile systems
- **Softline 70** (5-chamber) or **Softline 82** (7-chamber)
- **Filling:** Insert panel or top panel outside
- **Heat insulating glass:**
double thermal insulation glass, $U_g = 1.1 \text{ W/m}^2\text{K}$
triple thermal insulation glass, $U_g = 0.6 \text{ W/m}^2\text{K}$
- **Lock/fittings:** Winkhaus multi-point lock, latchbolt, deadbolt and 2 strong swing bolts at the top and bottom
- **Profile cylinder:** emergency and danger function, 3 keys
- **Outer handle:** Stainless steel bar door handle, 40 cm
- **Inner handle:** Stainless steel lever door handle
- **door hinges:** 3 stable door hinges, three-dimensionally adjustable

Standard models Prices upon request!

please indicate:

- Size
- Pattern inside/outside
- Model
- Insert panel or top panel
- Glass: patterned glass,
Double or triple glazing



Door panel: insert panel



Door panel: top panel

Handle set Standard - with price advantage!



Stainless steel bar door handle outside, approx. 40 cm long



Stainless steel lever door handle inside



Safety escutcheon, round



Safety escutcheon, oval

Product information:

- Maximum size available: 300 x 240 cm
- Minimum size available: 10 x 10 cm
- Minimum calculation size: 0,4 m²
- Space between panes: 16 mm

Technical data:

Insulating glass type WOLFA-Therm Ug 1.1 (W/m²K).

Light transmission	79%
Light reflection outside	11.5%
Solar transmittance	54 (according to DIN EN 410)
g-value	63 (according to DIN EN 410)
Color rendering index	98%
Air fill (4/16/4)	Ug 1.4 (W/m ² K) (DIN EN 673)
Argon fill (4/16/4)	Ug 1.1 (W/m ² K) (DIN EN 673)



Insulating glass: standard glass

Structure in mm	Price €/m ²	Minimum calculated price €
2 x 4	47	18.80
2 x 6	63	25.20
1 x 4 and 1 x 6	58	23.20
1 x 4 and 1 x 8 equals 37 db	64	25.60

Insulating glass: heat insulating glass

Insulating glasses double-paned WOLFA-Therm[®] Ug 1.1 (W/m²K):

Structure in mm	Price €/m ²	Minimum calculated price €
1 x 4 and 1 x 4 coated	58	23.20
1 x 6 and 1 x 4 coated	63	25.20
1 x 8 and 1 x 4 coated equals 37 db	74	29.60
1 x 8 and 1 x 6 coated	81	32.40



Insulating glass: Triple-paned insulating glass

Insulating glasses triple-paned WOLFA-Therm[®] Ug 0.7 or Ug 0.6 (W/m²K):

Structure in mm	Price €/m ²	Minimum calculated price €
4/12/4/12/4	88	35.20
4/16/4/16/4	93	37.20

! Surcharge for thermal edge bond rm €4

Insulating glass: surcharge patterned glass

Minimum size 0.4 m² in white. Other patterned glasses upon request

group
insulating glass types.



Altdeutsch k white
4 mm
51
20.40
Height
165 x 216



Chinchilla white
4 mm
40
16
optional
160 x 213



Delta white
4 mm
72
28.80
Height
165 x 213



ESG white
4 mm
47
18.80
-
165 x 216



Armored glass white
7 mm
71
28.40
optional
186 x 330



Wire ornament 187 white
7 mm
82
32.80
not considered
200 x 450



cathedral glass coarsely hammered
4 mm
24
9.60
optional
165 x 216



cathedral glass finely hammered
4 mm
24
9.60
optional
165 x 216



Madras Uadi white
4 mm
141
56.40
optional
225 x 321



Mastercarré white
4 mm
51
20.40
Height
200 x 321



Ornament 187 white
4 mm
56
22.40
not considered
165 x 216



Ornament 504 white
4 mm
24
9.60
optional
165 x 216



Ornament 523 white
4 mm
51
20.40
optional
165 x 216



Ornament raw glass white
5 mm
39
15.60
optional
210 x 125



Satinato white
4 mm
141
56.40
optional
225 x 321



Silvit 178 white
4 mm
27
10.80
Height
165 x 216



VSG (laminated safety glass) white
6 mm
46
18.40
optional
321 x 225



VSG (laminated safety glass) white
8 mm
64
25.60
optional
321 x 225

Legend:

Glass type
Color
Thickness in mm
Surcharge € / m ²
Min. calc. size € 0.4 m ²
Structural flow
Max. size in cm

General Conditions of Sale and Delivery (General Terms and Conditions)

I. General - Scope

Our General Terms and Conditions apply to vendors only as set forth in § 310 BGB. Our General Terms and Conditions have priority over any other third-party terms and conditions. We do not acknowledge any conditions of the buyer which oppose or differ from our General Terms and Conditions unless we have expressly approved their validity in writing. Our General Terms and Conditions shall also prevail if we execute delivery to the buyer without any reservation in the knowledge of conditions which oppose or deviate from our own. All agreements entered into by us and the buyer for the purpose of executing this contract shall be stipulated in writing in this contract. Our General Terms and Conditions also apply to all future business with the buyer.

II. Offer and Conclusion of Contract

An order of the purchaser which is to be classified as an offer for entry into a purchase contract can be accepted by us within 2 weeks by sending an order acknowledgment or by sending the products ordered within the same time period. Our offers are free and non-binding unless we have expressly stated their binding character. The information provided in our offers on dimensions, weights and colors etc. are approximate values as are custom in the industry, and therefore non-binding. We furthermore reserve the right to change and modify our products as needed and required by the state of the art without prior notice. We hereby reserve the ownership, copyright and other proprietary rights in all pictures, calculations, drawings and other documents. The buyer may forward above mentioned documents to third parties only with our express written approval irrespective of whether such documents are identified as confidential or not.

Prices

Unless indicated otherwise in our order acknowledgment, our prices are "ex works" and do not include packaging; packaging is invoiced separately. We reserve the right to change our prices in an appropriate manner if increases or decreases in costs take effect after conclusion of the contract in particular on the basis of collective wage agreements or increases in the price of commodities. We will provide evidence to the customer upon request. Our prices are quoted without statutory V.A.T.; instead, the statutory value-added tax applicable at the invoice date shall be indicated separately in the invoice.

Terms of Payment

The invoice amount (net prices + V.A.T.) is to be paid in Euros without any deductions within 30 days after the date of invoice. If payment is made within 14 days after the date of invoice, we are entitled to grant a 2% discount.

Discounts are granted only if all previous invoices have been paid in full. The basis for the calculation of discounts is the net invoice value after deduction of rebates, freight costs, value-added tax, etc.. We may demand immediate payment in cash only if we become aware of a significant deterioration of the buyer's financial circumstances or if we obtain information after the conclusion of the contract that the buyer had been in financial difficulties at the time the contract was signed. We are entitled to demand securities for all deliveries and services rendered up to such time; we also reserve the right to effect shipment only against payment in advance or cash on delivery, or to withdraw from the contract without the buyer being entitled to any claims against us. In this case, the buyer shall surrender the goods to us immediately and send them back to us at his expense. The provisions of the law shall apply if the buyer falls in arrears with a payment. The buyer shall only be entitled to set-off claims if the buyer's counter claims are undisputed, declared legally binding, or are recognized by us. The buyer shall furthermore be authorized to exercise a right of retention to the extent that his counterclaim is derived from the same contractual relationship.

Passing of Risk - Shipment/Packaging

All deliveries are effected "ex works" unless agreed upon otherwise. All shipments are effected at the expense of the orderer/buyer unless agreed otherwise. The freight costs for the transportation of goods within Germany result from the current price lists. Above a certain value which results from our current price lists we deliver carriage paid within Germany. Upon request and at the cost of the buyer we shall procure transport insurance for the shipment. Loading and shipment of the goods are effected non-insured and at the buyer's risk. We shall do our best to take the buyer's interest and wishes regarding shipping type and route into consideration; any additional costs, also in the case of agreed-upon free delivery, that may arise from such considerations shall be borne by the buyer. As provided for by the packaging regulations, shipping and all other packaging items with the exclusion of pallets are non-returnable. The buyer is to see to the disposal of packaging items at his own expense. If shipment is delayed by request or fault of the buyer, we shall store the goods at the buyer's expense and risk. In such case the notice of readiness for shipment is deemed as notice of shipment. We are entitled to make partial shipments at any time as far as the buyer can be reasonably expected to accept such part deliveries.

Delivery Periods and Deadlines

Dates or deadlines for delivery are not binding unless they have expressly been agreed upon as binding. The delivery time indicated by us shall not commence before all technical questions have been clarified. Likewise, the buyer shall fulfill all his obligations duly and without delay. The agreed date of delivery shall be regarded as having been complied with if the goods have left our factory or readiness for shipment has been communicated before expiration of the delivery date. Provided that the underlying purchase contract is a transaction to be settled on a fixed date in the sense of § 286 section 2 no 4 BGB (German Civil Code) or of § 376 HGB (German Commercial Code), we shall be liable as set forth by the legal provisions. The same shall apply in the event of a failure on our part to meet a delivery date which entitles the buyer to cancel further performance of the contract on the grounds that this is no longer in his interest. In such a case, our liability shall be limited to a predictable, typically occurring damage, if delayed delivery should not be based on any breach of contract attributable to us; whereby any fault of our representatives or vicarious agents shall be deemed to be attributable to us. We shall also be liable towards the buyer in terms of statutory provisions in the event of delivery delays, if such delay should be based on intentional or grossly negligent violation of the contract attributable to us; whereby any fault of our representatives or vicarious agents shall be deemed to be attributable to us.

Our liability is limited to the foreseeable, typically occurring damage if delayed delivery should not be based on any intentional breach of contract attributable to us. In the case that a delivery delay for which we are responsible involves the culpable breach of a significant contractual duty for which the blame can be assigned to our representative or agent, we are liable according to legal regulations provided that the liability for damages is limited in this case to the foreseeable, typically occurring damages. In all other cases the buyer may claim a flat reimbursement in the amount of 3% of the delivery value for every week of the delay but no more than a maximum of 15% of the delivery value, if we are responsible for the delay in delivery. Any further liability in respect of a default of delivery on the part of WOLFA is hereby excluded, notwithstanding any further legal claims and rights the buyer might have in addition to the claim for damages caused by us. If the buyer fails to accept delivery, we may claim damages and reimbursement of any additional expenses. The same shall apply where the buyer intentionally or negligently violates obligations to cooperate. In the event that the buyer has legally entered into default in accepting the goods or into debtor's delay, the risks of accidental deterioration and accidental destruction of the goods pass onto the buyer.

Warranty for Defects / Liability

Claims for defects shall only be recognized where the buyer has duly complied with his duties to examine the goods and to notify us of any defects as provided for in section 377 HGB (German Commercial Code). In so far as a defect exists for which we carry the liability, we shall be obliged to remedy such defect, provided that the buyer's rights to rescind the contract or to reduce the purchase price payable are waived, except in those instances where we may be entitled, in terms of the statutory provisions, to refuse to remedy the defect. The buyer shall concede a reasonable period of time for the remedying of defects. The buyer may choose between rectification of the defect (rework) or delivery of a new product. In the case of a rectification of a defect we will bear the necessary expenditures, in as far as those are not increased by the fact that the object of the contract is situated at a place other than the place of performance. If the remedying of defects is unsuccessful, the buyer may at his option require abatement of purchase price (reduction) or declare his withdrawal from the contract.

The remedying of defects shall be deemed to have failed upon two consecutive but unsuccessful attempts, except where further attempts appear appropriate and reasonably acceptable by the buyer. The buyer may only claim compensation according to the following conditions if the subsequent performance has failed. The right of the buyer to assert further claims according to the following conditions remains unaffected hereby. All claims for defects put forward by the buyer shall become statute barred one year following the consignment of the goods at the buyer unless we have fraudulently concealed the defect, in which event the provisions of law shall apply. The statutory provisions shall also apply in the case that we not only deliver but also assemble and install products which are in fact constructional materials. Our duties from the following sections 4 and 5 remain unaffected by this.

In accordance with the statutory provisions, we shall be obliged to accept a return of new products or a reduction of the purchase price, even where no due notice has been given by the buyer, if the buyer's client is to be considered a final purchaser of consumer products who is entitled to demand the return of the product or the reduction of the purchase price because of a defect of the product, or whenever the buyer is the addressee of such a claim by his client, who in turn sold the product to a final purchaser of consumer products. We shall moreover be obliged to compensate any expenses occurred to the buyer, particularly with regard to transport, carriage, labor and material costs, which the buyer had to bear for the end consumer within the framework of the subsequent performance due to any defect that existed at the time the risk associated with the goods was passed by us on to the buyer. This claim shall, however, be excluded if the buyer failed to fulfill his duties of inspection and notification of defects in terms of section 377 HGB (German Commercial Code). The obligation as in above subclause 4 is excluded if the defect is based on advertising representations or other contractual obligations that do not originate from us, or if the buyer has granted the end user additional warranties. Likewise, no claim shall be allowed if the buyer was in fact not under a statutory duty to entertain the claims put forward by the end user, or if the buyer did not object to the claims of an end user on those grounds. The same shall apply if the buyer has made warranties exceeding those stipulated by statutory provision.

We accept unlimited liability in accordance with the law for loss of life, bodily or health impairment that can be traced back to negligent or willful breach of duty by us, our legal representatives or vicarious agents, as well as for damage which is covered by the Product Liability Act. We shall be liable for damages not covered by the terms of the foregoing sentence, which are caused by willful or grossly negligent breaches of contract or deceit by us or by our legal representatives or vicarious agents as set forth in the statutory provisions. In this case, however, our liability for damage shall be limited to the foreseeable, typically occurring damage unless we, our legal representatives or our vicarious agents have acted grossly negligently. Within the extent that we have provided a guarantee of the composition and/or durability of goods or components, we shall also be liable within the scope of such guarantee. We shall, however, assume liability for damage resulting from the lack of guaranteed characteristics or durability but not occurring directly on the product itself only to the extent that the risk of such damage is clearly part of the guarantee covering characteristics and durability.

We shall also be liable for damage which is caused by ordinary negligence in so far as the negligence relates to the infringement of a contractual duty, whose observation is of special importance for the achievement of the contractual objective (cardinal obligation). Our liability, however, is limited to the fact that such damage is typically connected to the contract and thus foreseeable.

Any further liability is excluded irrespective of the legal nature of the claim; this applies particularly to tortious claims or claims for compensation for vain expenditures instead of performance; our liabilities resulting from paragraph VI, subclause 2 to paragraph VI subclause 5 of this contract remain unaffected hereby. In the event that our liability should be excluded or limited, the same shall also apply to the personal liability of our office employees, factory workforce, staff members, legal representatives and agents. Any damage claim the buyer puts forward on grounds of a defect shall expire one year after delivery of the goods. This shall not apply in the event of injury to life, limb or health which is our fault or that of our legal representatives or vicarious agents, or if we or our legal representatives have acted intentionally or with gross negligence, or if our simple vicarious agents have acted intentionally.

Reservation of Title

The supplied product (reserved goods) shall remain our property until all claims have been fulfilled including all account balance charges from current account which we have against the buyer now or in future. In the case of a behavior contrary to contract of the buyer, e.g. default of payment, we have the right to terminate the contract and to demand return of the goods after notice and setting of a proper time limit. Our acceptance of the return of the reserved goods constitutes a rescission of the contract. Our seizure of the reserved goods is equal to withdrawal from the contract. We are entitled to utilize the reserved goods after their return to us. After deduction of an adequate amount for the utilization costs, the utilization proceeds are to be set off against the amounts that are owed to us by the buyer.

The buyer shall treat the reserved goods with care and take out sufficient insurance at reinstatement value against damage from fire, water and theft. All maintenance and inspection jobs that may become necessary shall be carried out in good time by and at the expense of the buyer.

The buyer shall be entitled to duly sell and/or use the reserved goods in the course of business, provided the buyer is not in default of payment. Pledges or collateral assignments are prohibited. For reasons of security, the buyer shall as of now assign to the seller the full extent of all claims arising from the re-sale or any other legal reasons (e.g. insurance, tortious acts) in respect of the reserved goods (including all balance debts from current accounts). We grant the buyer the revocable right to collect the accounts receivable assigned to us on his own account and in his own name. Such authorization can be revoked at any time should the buyer fail to meet his payment obligations. The buyer is not entitled to transfer this claim, not even within the framework of claim collecting in the way of factoring, unless the factor declares his willingness to relinquish all payments to us as long as we still have claims against the buyer.

Processing or restructuring of the reserved goods by the customer is always carried out for us. As far as the reserved goods are processed together with other products which do not belong to us, we acquire the co-ownership in the new product in the proportion of the value of the reserved goods (total invoice amount incl. value added tax) to the other processed products at the time of processing. The product of such processing shall be subject to the same conditions as the reserved goods. In the case of the inseparable mixing of the reserved goods with other products which do not belong to us, we acquire co-ownership in the new product in the proportion of the value of the reserved goods (total invoice amount incl. value added tax) to the other mixed products at the time of the mixing. If the item of the buyer is to be deemed the main item due to the mixing, then the buyer and the seller agree that the buyer shall transfer proportionate joint ownership of the item to the seller; the seller hereby accepts the transfer. The buyer shall safekeep our resulting sole property or co-owned property for us. In the event of any action of third parties against the reserved goods, especially levy of execution, the buyer shall point out our ownership and notify us without delay so that we can enforce our property rights. As far as the third party is not able to reimburse the judicial or extrajudicial charges arising in this context, the buyer shall be liable to do so.

We shall release any security we hold if their value exceeds 10 per cent of the value of our claims against the buyer, provided that we shall be free to decide which specific securities are to be released.

Place of Performance and Jurisdiction

The place of performance and jurisdiction for deliveries and payments (including actions due to checks and bills of exchange) and all disputes arising between us and the buyer based on the purchase contracts concluded between us and the buyer shall be our registered office. We shall also be entitled, however, to sue the buyer at the buyer's domicile and/or registered office.

Final Provisions

The relationship between the contracting parties is subject exclusively to the laws of the Federal Republic of Germany. The application of the uniform law governing the international purchase of movable objects and the law governing the conclusion of international purchase contracts for movable objects is excluded. The buyer agrees that all data concerning the goods, the order and the persons involved can be recorded, saved and processed by us in the sense of and as required and enforced by the legal provisions. Should one of the above named provisions be or become void or impracticable or if the contract proves to be insufficiently formulated, the validity of the remaining provisions shall remain unaffected. Should one of the above named provisions be or become void or impracticable, the parties undertake to replace the invalid provision with a valid ruling closest to the sense and purpose of the contract and to the interests of both parties. The same applies if the contract proves to be insufficient or if the execution of one provision proves to be impracticable.

105 YEARS OF **WOLFA** – TRADITION, EXPERTISE, QUALITY



QUALITY MADE IN GERMANY – SINCE 1919



WOLFA headquarters Weikersheim
Production & Sales
Friedrich-Wolfarth-Straße 6
D - 97990 Weikersheim-Neubronn
Tel.: 0 79 34 / 91 91-0
Fax: 0 79 34 / 91 91-50
Email: mail@wolfa.de
Internet: www.wolfa.de



WOLFA location in Naumburg
Production & Distribution center
Südring 5
06618 Mertendorf OT Görtschen
Tel.: 0049 (0) 3 44 45 / 8 02-0
Fax: 0049 (0) 3 44 45 / 8 02-15
email: nl-goerschen@wolfa.de